



# POWER TOOLS 2022

Handheld Power Tools  
Stationary Power Tools





## POWER X-CHANGE

<b>Power X-Change Battery System</b>	<b>6</b>	Cordless Car Polishing Machine	37
Cordless Drills	10	Cordless Nailer	38
Cordless Impact Drills	14	Cordless Sealing Gun	38
Cordless Drywall Screwdriver	16	Cordless Paint Spray System	39
Cordless Impact Drivers	16	Cordless Radio	39
Cordless Impact Wrenches	17	Cordless Speaker	39
Cordless Impact Drill	17	Cordless Lights	40
Cordless Rotary Hammers	18	USB Battery Adapter	40
Cordless Paint/Mortar Mixer	20	Cordless Blower	41
Cordless Angle Grinders	21	Cordless Hot Glue Gun	41
Cordless Router/Cordless Palm Router	25	Cordless Hot Air Gun	41
Cordless Router	24	System Cases E-Case	42
Cordless Palm Router	26	Power X-Change Accessories – Cases // Bags	44
Cordless Biscuit Jointer	27	Cordless Wet and Dry Vacuum Cleaners	45
Cordless Planer	27	CordlessStick Vac Cleaner	47
Cordless Jigsaws	28	Cordless Handheld Vacuum Cleaner	48
Cordless Circular Saws	29	Cordless Ash Vacuum Cleaners	48
Cordless Mini Circular Saw	30	Cordless Push Sweeper	49
Cordless All Purpose Saws	31	Cordless Drain Cleaner	50
Cordless Sliding Mitre Saw	32	6-in-1 Cordless Hybrid Compressor	51
Cordless Mitre Saw	32	3-in-1 Cordless Compressor	52
Cordless Table Saw	33	Cordless Compressors	52
Cordless Band Saws	33	Cordless Car Compressor	53
Cordless Multifunctional Tools	34	Cordless Air Pump	53
Cordless Drywall Polisher	34	Cordless Tile Cutting Machine	54
Cordless Band Sander	35	Power X-Change Accessories – Batteries // Chargers // Starter Kits	55
Cordless Orbital Sanders	35	The Battery Guide – Running time tables	59
Cordless Multi Sander	36	Kickscooter ELMOTO KICK	63
Cordless Rotating Sander	36		
Cordless Polishing/Sanding Machine	37		



## HANDHELD POWER TOOLS

<b>Screwing</b>	<b>64</b>	Multifunctional Tools	83
Cordless Screwdrivers 3.6 V	65	Cordless Multifunctional Tool	83
Cordless Drills 12 V	65	<b>Grinding / Sanding</b>	<b>84</b>
Cordless Impact Drill 12 V	67	Cordless Grinding and Engraving Tool	84
Cordless Impact Driver 12 V	67	Grinding and Engraving Tool	84
Drywall Screwdriver	68	Orbital Sanders	85
<b>Drilling + Mixing</b>	<b>68</b>	Band Sanders	85
Impact Drills	68	Delta Sanders	86
Rotary Hammers 2 kg class	70	Multi Sanders	86
Rotary Hammers 5 kg class	71	Rotating Sanders	87
Demolition Hammers	73	Wall and Concrete Grinder	87
Paint/Mortar Mixers	74	Drywall Polishers	88
<b>Cutting</b>	<b>75</b>	<b>Electric Paint Spry Systems</b>	<b>89</b>
Angle Grinders 230 mm	75	Electric Paint Spray Systems (semi-stationary)	89
Angle Grinders 125 mm	75	Electric Paint Spray Systems (Spray Gun)	89
Angle Grinder 115 mm	76	<b>More Power Tools</b>	<b>90</b>
<b>Milling + Planing</b>	<b>77</b>	Hot Glue Gun	90
Wall Liners	77	Cordless Hot Glue Gun	90
Biscuit Jointer	77	Electric Tacker	90
Routers	78	Cordless Tacker	90
Planers	78	Hot Air Guns	91
<b>Sawing</b>	<b>79</b>	<b>Laser + Detector Technology</b>	<b>92</b>
Jigsaws	79	360° Cross Laser Level	92
Circular Saws	80	Cross Laser Level	93
Plunge Cut Saw	81	Laser Distance Meters	94
Mini Circular Saw	81	Laser Levelling	95
All Purpose Saws	82	Digital Detector	95



## STATIONARY POWER TOOLS

<b>Woodworking</b>	<b>98</b>
Sliding Mitre Saws	98
Mitre Saws	100
Mitre Saws with Upper Table	100
Table Saws with Base Frame	101
Table Saws	103
Stationary Planer	104
Scroll Saw	104
Band Saws	105
Woodworking Lathe	106
Vacuum Extraction System	106
<b>Cleaning Systems</b>	<b>107</b>
Wet and Dry Vacuum Cleaners	108
Ash Vacuum Cleaners	111
High Pressure Cleaners	113
<b>Compressed Air Technology</b>	<b>114</b>
Silent Air Compressors	115
Belt-driven Compressor	116
Oil-lubricated Compressors	116
Oil-free Compressors	118
Air Tools + Accessories	119
<b>Stationary Grinding</b>	<b>123</b>
Bench Grinders	123
Wet Grinder	124
Wet-Dry Grinder	124
Stationary Belt-Disc Sanders	125

<b>Metalworking</b>	<b>125</b>
Metal Cutting Saw	125
<b>Stationary Drilling</b>	<b>126</b>
Bench Drills	127
<b>Stone and Tile Cutting</b>	<b>128</b>
Stone Cutting Machines	128
Tile Cutting Machines	129
<b>Hoisting</b>	<b>130</b>
Electric Hoists	130
Chain Hoist	131
Hoist Lever Arm	131
Hand Lever Hoists	132
Hand Rope Winches	132
<b>Workshop Equipment</b>	<b>133</b>
Pallet Truck	133
Work Bench	133
Tool and Gear Waggons	133
<b>Power Generating</b>	<b>134</b>
Inverter Generators (Petrol)	134
Power Generators (Petrol)	134
<b>Accessories</b>	<b>136</b>
Accessories – Handheld Power Tools	136
Accessories – Stationary Power Tools	145

<b>Sales Support</b>	<b>160</b>
----------------------	------------

<b>Service</b>	<b>164</b>
----------------	------------

### THE EINHELL GUARANTEE PROMISE.

We develop our products so that you can make everything possible. Our priority here is functionality, safety and quality. That is our promise and this is backed up by our guarantees too.

- **30 Day Money-Back Guarantee**  
For 100% satisfaction with your Power X-Change device.
- **Power X-Change Battery Warranty**  
Warranty extension for Power X-Change batteries to 2 years.
- **Einhell 2+1 Product Warranty**  
Warranty extension for all Einhell products to a total of 3 years.



### THIS IS HOW:

Find out more at [einhell.de](http://einhell.de), register in your customer account and apply for the warranty. Further information is available at [www.einhell.de/warranties](http://www.einhell.de/warranties)

[einhell.de](http://einhell.de)  
>>>

# EINHELL IS GOLD PARTNER OF FC BAYERN!



## WE ARE PARTNER. EINHELL AND FC BAYERN.

In our search for a partner for whom performance and endurance are just as important as they are for us, who values power and flexibility and consistently pursues their goals, we have found what we were looking for: As of August 2021, **Einhell as Gold Partner has been appointed as an Home & Garden Expert of FC Bayern.** Whether on the pitch or around the Allianz Arena: Be there when we implement exciting projects with the power and garden tools of our Power X-Change battery system enabling the players to **make everything possible** on the pitch.



*"We need people by our side who love what they do. Who have mastered their technique. Who take us forward. We need a partner with whom we can make any mission possible. And there can only be one."*

Oliver Kahn, CEO, FC Bayern München AG

## A PARTNERSHIP. ON THE SAME LEVEL.

Inspire people by giving your all every day. Working as a team with performance and perseverance to meet every challenge. And thereby convince with their own technology and competence. Einhell and FC Bayern not only share a love of their home in the heart of Bavaria, but especially also common values and the same mindset. As the team behind the FC Bayern team, we are now the club's Official Home and Garden Expert, the experts and enablers for smooth match and training operations.

**Powerful enabler meets German record champion. The mission? Enabling the Next Level!**

# BATTERY EXPERTISE. CONVINCING. AGAIN AND AGAIN.

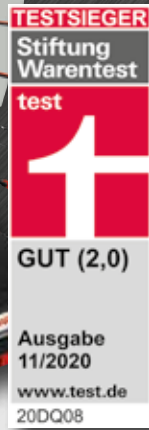

*"We are incredibly proud to have done so well in a race with the very top competitors and to have been able to demonstrate our battery expertise so clearly. We are battery test winners."*

Andreas Kroiss, CEO, Einhell Germany AG



## WE ARE TEST WINNERS. BY STIFTUNG WARENTEST.



And the test winner is ... Einhell!

In the comparison test performed by Stiftung Warentest (11/2020 issue) covering eight batteries from eight different battery platforms, the 2.0 Ah battery from Einhell's Power X-Change battery system beat off stiff competition. Our battery put in a convincing performance when it came to durability, handling and safety. Having already achieved top marks with Power X-Change machines in previous

Stiftung Warentest comparisons, we are all the more delighted that one of the batteries we have spent so much time developing and refining came out of the test on top. This confirms the decision we took years ago to bundle our expertise in the battery technology sector in order to continue expanding the leading role of our Power X-Change battery system.



**CORDLESS FREEDOM.  
FOR TOOL AND GARDEN.**

**At last – no more too short or severed cables.**

When you have no longer to worry about extension cables that are too short or sufficient sockets. When the device comes to the project instead of the other way round. When you simply insert the battery and are ready to go, whether it is a lawn mower, garden pump, rotary hammer or wet and dry vacuum cleaner. Than that is the feeling of cordless freedom.



**LATEST TECHNOLOGY.  
PROVEN QUALITY.**

**So you can enjoy using your machine for a very long time.**

The Power X-Change batteries are the centerpiece of the platform. That is why we use only the best components such as high-performance Li-Ion cells and our intelligent ABS battery electronics in the batteries. This makes our PXC battery one of the safest in the industry and ensures efficiency, reliability and durability. Stiftung Warentest (11/2020 issue) confirmed its quality in a comparison test with eight batteries from eight different battery platforms. The 2.0 Ah battery from the Power X-Change battery system from Einhell beat off stiff competition to emerge as test winner.



**POWERFUL MACHINES.  
LONG-LASTING BATTERIES.**

**No matter how large your project – Power X-Change won't let you down.**

Less power? No way! As a battery system for real enablers, our cordless machines offer up to 2700 Watt of battery power and 6 Ah of capacity, making them easily a match for corded machines! Whether you just want to hang a shelf or drill through a solid concrete wall, with Power X-Change you are equipped to meet any challenge with power and endurance.



**1 BATTERY. 1000 POSSIBILITIES.  
FOR DIY ENTHUSIASTS AND HOBBY GARDENERS.**

**Just as versatile as you: Battery power for every situation.**

Power X-Change is the first rechargeable battery system that provides hobby gardeners and DIY enthusiasts alike with an unrivaled selection of cordless tools. The PXC family already contains over 200 devices – and the number is constantly rising. Thanks to the versatile Power X-Change system, for instance, the electric kick scooter from GOVECS is "powered by Power X-Change".



### ACTIVE BATTERY MANAGEMENT SYSTEM. INTELLIGENT ELECTRONIC CONTROL SYSTEM.

The computer-assisted Active Battery Management System permanently monitors and controls all the safety-related processes of the electrical components and associated hardware. This results in a whole range of advantages:

- MAXIMISED RUNNING TIMES
- OPTIMISED TOOL POWER
- LONGER BATTERY SERVICE LIFE
- INCREASED SAFETY



### TWIN-PACK® TECHNOLOGY. 18 V + 18 V = 36 V.

If a device needs more power than provided by a single 18 V rechargeable battery, we simply add a second battery so we generate 18 V + 18 V = 36 V. We call that Twin-Pack® Technology.

If the voltage (V) gets doubled, the power (W) gets doubled, too. Double Twin-Pack Technology in turn makes it possible to work for even longer still without the nuisance of recharging. In this case, four rechargeable batteries are used. When the power of the first two batteries finally runs out, the system automatically switches over to the two additional batteries.



### POWER X-CHANGE PLUS. THE PLUS IN POWER.

Rechargeable batteries vary not just in terms of running time and weight. What is also critically important is the power that they provide. Power X-Change PLUS Technology makes more power available from the same number of cells, so that you can work with plenty of power even on challenging applications as well.

If, for example, you want to use your angle grinder for cutting work, the running time (see Ah rating) is generally not critical. Sufficient power, on the other hand, is. A car is a useful comparison. Uphill or when overtaking, more power, in other words more hp respectively kW, is needed.

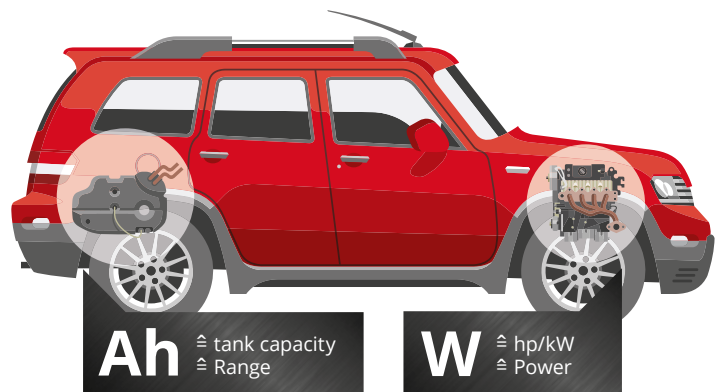

### BRUSHLESS ENERGY – MORE EFFICIENT WORK.

Various Power X-Change devices are equipped with brushless motors. They offer significant advantages compared to carbon brush motors:

- MORE POWER
- LONGER RUNNING TIMES
- LONGER SERVICE LIFE
- MORE COMPACT DESIGN
- MAINTENANCE-FREE



- 25%** more power\*
- 50%** more operating time\*
- 100%** more service life\*

\* Approximate values in comparison to conventional carbon brush motors



# Einhell

CORDLESS EXCELLENCE.



**1 BATTERY.**

**FOR MORE THAN 200 TOOLS.**





**ONLY FROM EINHELL.**

## CORDLESS DRILLS 18 V



	<b>TP-CD 18/60 Li BL - Solo</b> <b>PROFESSIONAL</b> <span style="float: right;"><b>NEW</b></span>
PXC battery voltage / capacity	18 V / -
Charging time	-
Idle speed	0 - 500 / 0 - 2000 min <sup>-1</sup>
Torque (hard)	60 Nm
Torque settings	21+1
Drill chuck	13 mm
Product weight	1.3 kg (excl. battery)
Brushless motor	•
Metal drill chuck	•
Metal gear box	•
Number of removable attachments	-
LED	•
Belt clip	•
Accessories	-
Number of batteries / number of chargers	0 / 0
Additional handle	•
Packaging	Colour box
Article number	45.142.10



## CORDLESS DRILLS 18 V



	<b>TP-CD 18/50 Li BL - Solo</b> <b>PROFESSIONAL</b>	<b>TP-CD 18/50 Li BL (2x 2.0 Ah)</b> <b>PROFESSIONAL</b>
PXC battery voltage / capacity	18 V / -	18 V / 2.0 Ah
Charging time	-	40 min
Idle speed	0 - 500 / 0 - 1800 min <sup>-1</sup>	0 - 500 / 0 - 1800 min <sup>-1</sup>
Torque (hard)	50 Nm	50 Nm
Torque settings	19+1	19+1
Drill chuck	13 mm	13 mm
Product weight	1.2 kg (excl. battery)	1.6 kg (incl. battery)
Brushless motor	•	•
Metal drill chuck	-	-
Metal gear box	•	•
Number of removable attachments	-	-
LED	•	•
Belt clip	•	•
Accessories	-	-
Number of batteries / number of chargers	0 / 0	2 / 1x Power X-Charger 3 A
Additional handle	-	-
Packaging	Colour box	E-Box Basic
Article number	45.138.87	45.138.96



**CORDLESS DRILLS 18 V**



PXC battery voltage / capacity	18 V / -
Charging time	-
Idle speed	0 - 350 / 0 - 1450 min <sup>-1</sup>
Torque (hard)	40 Nm
Torque settings	20+1
Drill chuck	10 mm
Product weight	0.8 kg (excl. battery)
Brushless motor	•
Metal drill chuck	-
Metal gear box	-
Number of removable attachments	-
LED	•
Belt clip	-
Accessories	-
Number of batteries / number of chargers	0 / 0
Additional handle	-
Packaging	Colour box
Article number	45.139.97

<b>TE-CD 18/40 Li BL - Solo</b>	<b>TE-CD 18/40 Li BL (2x 2.0 Ah)</b>
<b>EXPERT</b>	<b>EXPERT</b>
18 V / -	18 V / 2.0 Ah
-	40 min
0 - 350 / 0 - 1450 min <sup>-1</sup>	0 - 350 / 0 - 1450 min <sup>-1</sup>
40 Nm	40 Nm
20+1	20+1
10 mm	10 mm
0.8 kg (excl. battery)	1.2 kg (incl. battery)
•	•
-	-
-	•
-	-
•	•
-	-
-	-
0 / 0	2 / 1x Power X-Charger 3 A
-	-
Colour box	E-Box Basic
45.139.97	45.139.95



**CORDLESS DRILLS 18 V**



PXC battery voltage / capacity	18 V / -
Charging time	-
Idle speed	0 - 400 / 0 - 1400 min <sup>-1</sup>
Torque (hard)	47 Nm
Torque settings	8+1
Drill chuck	13 mm
Product weight	1.1 kg (excl. battery)
Brushless motor	-
Metal drill chuck	-
Metal gear box	•
Number of removable attachments	-
LED	•
Belt clip	•
Accessories	-
Number of batteries / number of chargers	0 / 0
Additional handle	-
Packaging	Colour box
Article number	45.138.70

<b>TE-CD 18 Li E - Solo</b>	<b>TE-CD 18/45 3X-Li +22 (1x 2.0 Ah)</b>
<b>EXPERT</b>	<b>EXPERT</b>
18 V / -	18 V / 2.0 Ah
-	40 min
0 - 400 / 0 - 1400 min <sup>-1</sup>	0 - 450 / 0 - 1600 min <sup>-1</sup>
47 Nm	45 Nm
8+1	20+1
13 mm	13 mm
1.1 kg (excl. battery)	1.5 kg (incl. battery)
-	-
-	-
•	•
-	3
•	•
•	•
-	22-piece in bit box
0 / 0	1 / 1x Power X-Charger 3 A
-	-
Colour box	E-Box Basic
45.138.70	45.139.90



## CORDLESS DRILLS 18 V

**40 Nm  
HIGH  
POWER**



	<b>TE-CD 18/40 Li - Solo</b> <b>EXPERT</b>	<b>TE-CD 18/40-1 Li (2x 1.5 Ah)</b> <b>EXPERT</b>
PXC battery voltage / capacity	18 V / -	18 V / 1.5 Ah
Charging time	-	30 min
Idle speed	0 - 400 / 0 - 1500 min <sup>-1</sup>	0 - 400 / 0 - 1500 min <sup>-1</sup>
Torque (hard)	40 Nm	40 Nm
Torque settings	20+1	20+1
Drill chuck	13 mm	13 mm
Product weight	1.1 kg (excl. battery)	1.5 kg (incl. battery)
Brushless motor	-	-
Metal drill chuck	-	-
Metal gear box	•	•
Number of removable attachments	-	-
LED	•	•
Belt clip	•	•
Accessories	-	-
Number of batteries / number of chargers	0 / 0	2 / 1x Power X-Charger 3 A
Additional handle	-	-
Packaging	Colour box	Case
Article number	45.139.25	45.139.39



## CORDLESS DRILLS 18 V

**EXTENSIVE  
ACCESSORY**



	<b>TE-CD 18/40 Li +69 (2x 2.0 Ah)</b> <b>EXPERT</b>	<b>TE-CD 18/40 Li +69 (1x 2.5 Ah)</b> <b>EXPERT</b>
PXC battery voltage / capacity	18 V / 2.0 Ah	18 V / 2.5 Ah
Charging time	40 min	50 min
Idle speed	0 - 400 / 0 - 1500 min <sup>-1</sup>	0 - 400 / 0 - 1500 min <sup>-1</sup>
Torque (hard)	40 Nm	40 Nm
Torque settings	20+1	20+1
Drill chuck	13 mm	13 mm
Product weight	1.5 kg (incl. battery)	1.5 kg (incl. battery)
Brushless motor	-	-
Metal drill chuck	-	-
Metal gear box	•	•
Number of removable attachments	-	-
LED	•	•
Belt clip	•	•
Accessories	69-piece	69-piece
Number of batteries / number of chargers	2 / 1x Power X-Charger 3 A	1 / 1x Power X-Charger 3 A
Additional handle	-	-
Packaging	Robust case with several compartments for accessories	Robust case with several compartments for accessories
Article number	45.139.34	45.139.55



## CORDLESS DRILLS 18 V



	TE-CD 18/2 Li Kit (2x 1.5 Ah) <b>EXPERT</b>	TE-CD 18/2 Li +39 (1x 2.5 Ah) <b>EXPERT</b> <span style="float: right;"><b>NEW</b></span>
PXC battery voltage / capacity	18 V / 1.5 Ah	18 V / 2.5 Ah
Charging time	30 min	50 min
Idle speed	0 - 350 / 0 - 1250 min <sup>-1</sup>	0 - 350 / 0 - 1250 min <sup>-1</sup>
Torque (hard)	44 Nm	44 Nm
Torque settings	20+1	20+1
Drill chuck	10 mm	10 mm
Product weight	1.4 kg (incl. battery)	1.4 kg (incl. battery)
Brushless motor	-	-
Metal drill chuck	-	-
Metal gear box	•	•
Number of removable attachments	-	-
LED	•	•
Belt clip	•	•
Accessories	-	39-piece in bit box
Number of batteries / number of chargers	2 / 1x Power X-Charger 3 A	1 / 1x Power X-Charger 3 A
Additional handle	-	-
Packaging	Case	E-Box Basic
Article number	45.138.30	45.142.19



## CORDLESS DRILLS 18 V



	TC-CD 18/35 Li - Solo <b>CLASSIC</b>	TC-CD 18/35 Li (1x 1.5 Ah) <b>CLASSIC</b>
PXC battery voltage / capacity	18 V / -	18 V / 1.5 Ah
Charging time	-	30 min
Idle speed	0 - 550 min <sup>-1</sup>	0 - 550 min <sup>-1</sup>
Torque (hard)	35 Nm	35 Nm
Torque settings	20+1	20+1
Drill chuck	10 mm	10 mm
Product weight	1.0 kg (excl. battery)	1.3 kg (incl. battery)
Brushless motor	-	-
Metal drill chuck	-	-
Metal gear box	•	•
Number of removable attachments	-	-
LED	•	•
Belt clip	-	-
Accessories	-	-
Number of batteries / number of chargers	0 / 0	1 / 1x Power X-Charger 3 A
Additional handle	-	-
Packaging	Colour box	Colour box
Article number	45.139.27	45.139.14



## CORDLESS IMPACT DRILLS 18 V



	<b>TP-CD 18/60 Li-i BL - Solo</b> <b>PROFESSIONAL</b> <span style="float: right;"><b>NEW</b></span>	<b>TP-CD 18/60 Li-i BL +39 (2x 2.0 Ah)</b> <b>PROFESSIONAL</b> <span style="float: right;"><b>NEW</b></span>
PXC battery voltage / capacity	18 V / -	18 V / 2.0 Ah
Charging time	-	40 min
Idle speed	0 - 500 / 0 - 2000 min <sup>-1</sup>	0 - 500 / 0 - 2000 min <sup>-1</sup>
Blow rate	0 - 8000 / 0 - 32000 min <sup>-1</sup>	0 - 8000 / 0 - 32000 min <sup>-1</sup>
Torque (hard)	60 Nm	60 Nm
Torque settings	21+1+1	21+1+1
Drill chuck	13 mm	13 mm
Product weight	1.3 kg (excl. battery)	1.7 kg (incl. battery)
Brushless motor	•	•
Metal drill chuck	•	•
Metal gear box	•	•
Number of removable attachments	-	-
LED	•	•
Number of batteries / number of chargers	0 / 0	2 / 1x Power X-Charger 3 A
Additional handle	•	•
Accessories	-	39-piece in bit box
Packaging	Colour box	E-Box Basic
Article number	45.142.05	45.142.06



## CORDLESS IMPACT DRILLS 18 V



	<b>TP-CD 18/50 Li-i BL - Solo</b> <b>PROFESSIONAL</b>	<b>TP-CD 18/50 Li-i BL (2x 2.0 Ah)</b> <b>PROFESSIONAL</b>
PXC battery voltage / capacity	18 V / -	18 V / 2.0 Ah
Charging time	-	40 min
Idle speed	0 - 500 / 0 - 1800 min <sup>-1</sup>	0 - 500 / 0 - 1800 min <sup>-1</sup>
Blow rate	0 - 8000 / 0 - 28800 min <sup>-1</sup>	0 - 8000 / 0 - 28800 min <sup>-1</sup>
Torque (hard)	50 Nm	50 Nm
Torque settings	20+1+1	20+1+1
Drill chuck	13 mm	13 mm
Product weight	1.2 kg (excl. battery)	1.6 kg (incl. battery)
Brushless motor	•	•
Metal drill chuck	•	•
Metal gear box	•	•
Number of removable attachments	-	-
LED	•	•
Number of batteries / number of chargers	0 / 0	2 / 1x Power X-Charger 3 A
Additional handle	-	-
Accessories	-	-
Packaging	Colour box	E-Box Basic
Article number	45.139.42	45.139.40



## CORDLESS IMPACT DRILLS 18 V

**48 Nm  
HIGH  
POWER**



	<b>TE-CD 18/48 Li-i - Solo</b> <b>EXPERT</b>	<b>TE-CD 18/48 Li-i (2x 2.0 Ah)</b> <b>EXPERT</b>
PXC battery voltage / capacity	18 V / -	18 V / 2.0 Ah
Charging time	-	40 min
Idle speed	0 - 400 / 0 - 1500 min <sup>-1</sup>	0 - 400 / 0 - 1500 min <sup>-1</sup>
Blow rate	0 - 6400 / 0 - 24000 min <sup>-1</sup>	0 - 6400 / 0 - 24000 min <sup>-1</sup>
Torque (hard)	48 Nm	48 Nm
Torque settings	21+1+1	21+1+1
Drill chuck	13 mm	13 mm
Product weight	1.3 kg (excl. battery)	1.7 kg (incl. battery)
Brushless motor	-	-
Metal drill chuck	•	•
Metal gear box	•	•
Number of removable attachments	-	-
LED	•	•
Number of batteries / number of chargers	0 / 0	2 / 1x Power X-Charger 3 A
Additional handle	•	•
Accessories	-	-
Packaging	Colour box	E-Box Basic
Article number	45.139.26	45.139.35



## CORDLESS IMPACT DRILLS 18 V

**3 FUNCTIONS**



	<b>TE-CD 18/2 Li-i +22 (1x 2.5 Ah)</b> <b>EXPERT</b> <b>NEW</b>	<b>TE-CD 18/2 Li-i +64 (2x 2.0 Ah)</b> <b>EXPERT</b> <b>NEW</b>	<b>TE-CD 18/40 Li-i +64 (2x 2.0 Ah)</b> <b>EXPERT</b> <b>NEW</b>
PXC battery voltage / capacity	18 V / 2.5 Ah	18 V / 2.0 Ah	18 V / 2.0 Ah
Charging time	50 min	40 min	40 min
Idle speed	0 - 350 / 0 - 1250 min <sup>-1</sup>	0 - 350 / 0 - 1250 min <sup>-1</sup>	0 - 400 / 0 - 1500 min <sup>-1</sup>
Blow rate	0 - 5250 / 0 - 18750 min <sup>-1</sup>	0 - 5250 / 0 - 18750 min <sup>-1</sup>	0 - 6400 / 0 - 24000 min <sup>-1</sup>
Torque (hard)	44 Nm	44 Nm	40 Nm
Torque settings	21+1+1	21+1+1	21+1+1
Drill chuck	13 mm	13 mm	13 mm
Product weight	1.5 kg (incl. battery)	1.5 kg (incl. battery)	1.5 kg (incl. battery)
Brushless motor	-	-	-
Metal drill chuck	•	•	•
Metal gear box	•	•	•
Number of removable attachments	-	-	-
LED	•	•	•
Number of batteries / number of chargers	1 / 1x Power X-Charger 3 A	2 / 1x Power X-Charger 3 A	2 / 1x Power X-Charger 3 A
Additional handle	-	-	-
Accessories	22-piece in bit box	64-piece	64-piece
Packaging	E-Box Basic	Robust case with several compartments for accessories	Robust case with several compartments for accessories
Article number	45.142.20	45.142.21	45.139.92



## CORDLESS DRYWALL SCREWDRIVER 18 V



	<b>TE-DY 18 Li - Solo</b> <b>EXPERT</b>
PXC battery voltage / capacity	18 V / -
Idle speed	0 - 4000 min <sup>-1</sup>
Torque (soft)	6 Nm
Bit mount	Internal hexagon 6.35 mm (1/4")
Product weight	0.9 kg (excl. battery)
Adjustment without tools (depth)	•
Speed control electronics	•
Continuous operation setting	•
Soft grip	•
LED	•
Belt clip	•
Number of batteries / number of chargers	0 / 0
Accessories	1x bit type PH2 S2
Packaging	E-Box
Article number	42.599.80



## CORDLESS IMPACT DRIVERS 18 V



**180 Nm /  
140 Nm  
HIGH  
POWER**

	<b>TP-CI 18 Li BL - Solo</b> <b>PROFESSIONAL</b>	<b>TE-CI 18/1 Li - Solo</b> <b>EXPERT</b>
PXC battery voltage / capacity	18 V / -	18 V / -
Charging time	-	-
Idle speed	0 - 2900 min <sup>-1</sup>	0 - 2300 min <sup>-1</sup>
Torque (hard)	180 Nm	140 Nm
Number of torque settings	-	-
Bit mount	Internal hexagon 6.35 mm (1/4")	Internal hexagon 6.35 mm (1/4")
Product weight	1.1 kg (excl. battery)	1.2 kg (excl. battery)
Brushless motor	•	-
LED	•	•
Metal gear box	•	•
Electronic speed control	•	•
Belt clip	•	•
Number of batteries / number of chargers	0 / 0	0 / 0
Accessories	-	-
Packaging	Colour box	Colour box
Article number	45.100.30	45.100.34





## CORDLESS IMPACT WRENCHES 18 V



Illustration similar

	<b>IMPAXXO 18/400</b> <b>PROFESSIONAL</b> <span style="float: right;"><b>NEW</b></span>	<b>IMPAXXO 18/230</b> <b>PROFESSIONAL</b> <span style="float: right;"><b>NEW</b></span>
PXC battery voltage / capacity	18 V / -	18 V / -
Charging time	-	-
Idle speed	0 - 1000 min <sup>-1</sup> / 0 - 1500 min <sup>-1</sup> / 0 - 2100 min <sup>-1</sup>	0 - 2900 min <sup>-1</sup>
Torque (hard)	400 Nm	230 Nm
Number of torque settings	3	-
Bit mount	12.5 mm (1/2") external square drive mount	12.5 mm (1/2") external square drive mount
Product weight	2.0 kg (excl. battery)	1.1 kg (excl. battery)
Brushless motor	•	•
LED	•	•
Metal gear box	•	•
Electronic speed control	•	•
Belt clip	•	•
Number of batteries / number of chargers	0 / 0	0 / 0
Accessories	Bit adapter, 3-piece nut set	Bit adapter
Packaging	Colour box	Colour box
Article number	45.100.70	45.100.80



## CORDLESS IMPACT DRILL



	<b>TC-ID 18 Li - Solo</b> <b>CLASSIC</b>
PXC battery voltage / capacity	18 V / -
Charging time	-
Idle speed / blow rate	0 - 2600 min <sup>-1</sup> / 0 - 41600 min <sup>-1</sup>
Drilling capacity, wood	25 mm
Drilling capacity, cement	13 mm
Drilling capacity, steel	10 mm
Drill chuck	13 mm
Product weight	1.6 kg (excl. battery)
Speed control electronics	•
Soft grip	•
Number of batteries / number of chargers	0 / 0
Additional handle	•
Metal depth stop	•
Packaging	Colour box
Article number	45.139.60



# CORDLESS ROTARY HAMMERS

Cordless Rotary Hammer  
**HEROCCO 36/28**



- **ANTI-VIBRATION**  
Comfortable to work with thanks to vibration-absorbing main handle
- **ELECTRONIC SPEED CONTROL**  
The right speed for every application
- **4 FUNCTIONS**  
Drilling, screwing, impact drilling, chiselling with fixation
- **PNEUMATIC HAMMER MECHANISM**  
Only slight pressure needs to be applied to achieve high impact force
- **POWER X-CHANGE LI ION BATTERY / TWIN-PACK TECHNOLOGY**  
The rechargeable battery can be used in all the devices from the Power X-Change family – using 2x 18 V Power X-Change rechargeable batteries delivers even more power
- **INTEGRATED LED**  
Well illuminated work area even in poor lighting conditions

## CORDLESS ROTARY HAMMER 36 V

**TWIN-PACK®**  
18V + 18V → 36V  
TECHNOLOGY



**BRUSHLESS MOTOR**  
More power and prolonged operation



	<b>HEROCCO 36/28</b> <b>PROFESSIONAL</b>
PXC battery voltage / capacity	2x 18 V / -
Charging time	-
Idle speed / blow rate / impact force	0 - 1100 min <sup>-1</sup> / 0 - 5300 min <sup>-1</sup> / 3.2 J
Drilling capacity, cement	28 mm
Drill chuck	SDS-plus
Product weight	3.4 kg (excl. battery)
Brushless motor	•
Speed control electronics	•
Vibration-cushioned main handle	•
Overload safety stop	•
Pneumatic impact mechanism	•
Functions	4
LED	•
Automatic lock	•
Soft grip	•
Number of batteries / number of chargers	0 / 0
Additional handle	•
Metal depth stop	•
Accessories	-
Packaging	E-Box
Article number	45.139.50

**HEROCCO**



## CORDLESS ROTARY HAMMERS 18 V

**INCL. BIT ADAPTER**



HEROCCO 18/20 <b>PROFESSIONAL</b>	
PXC battery voltage / capacity	18 V / -
Charging time	-
Idle speed / blow rate / impact force	0 - 1200 min <sup>-1</sup> / 0 - 5500 min <sup>-1</sup> / 2.2 J
Drilling capacity, cement	20 mm
Drill chuck	SDS-plus
Product weight	2.1 kg (excl. battery)
Brushless motor	•
Speed control electronics	•
Vibration-cushioned main handle	•
Overload safety stop	•
Pneumatic impact mechanism	•
Functions	4+1
LED	•
Automatic lock	•
Soft grip	•
Number of batteries / number of chargers	0 / 0
Additional handle	•
Metal depth stop	•
Accessories	1 magnetic bit adapter
Packaging	E-Box
Article number	45.139.00



## CORDLESS ROTARY HAMMERS 18 V

**2+1 FUNCTIONS**



TE-HD 18 Li Kit (1x 2.5 Ah) <b>EXPERT</b>	
PXC battery voltage / capacity	18 V / 2.5 Ah
Charging time	50 min
Idle speed / blow rate / impact force	0 - 1100 min <sup>-1</sup> / 0 - 5700 min <sup>-1</sup> / 1.2 J
Drilling capacity, cement	12 mm
Drill chuck	SDS-plus
Product weight	1.4 kg (excl. battery)
Brushless motor	-
Speed control electronics	•
Vibration-cushioned main handle	-
Overload safety stop	•
Pneumatic impact mechanism	•
Functions	2+1
LED	•
Automatic lock	•
Soft grip	•
Number of batteries / number of chargers	1 / 1x Power X-Charger 3 A
Accessories	1 magnetic bit adapter, 5 SDS-plus drill bits
Packaging	E-Box Basic
Article number	45.142.18



TE-HD 18/12 Li - Solo <b>EXPERT</b>	
PXC battery voltage / capacity	18 V / -
Charging time	-
Idle speed / blow rate / impact force	0 - 1300 min <sup>-1</sup> / 0 - 6000 min <sup>-1</sup> / 1.3 J
Drilling capacity, cement	12 mm
Drill chuck	SDS-plus
Product weight	1.5 kg (excl. battery)
Brushless motor	-
Speed control electronics	•
Vibration-cushioned main handle	-
Overload safety stop	•
Pneumatic impact mechanism	•
Functions	2+1
LED	•
Automatic lock	•
Soft grip	•
Number of batteries / number of chargers	0 / 0
Accessories	1 magnetic bit adapter
Packaging	Colour box
Article number	45.139.70



# CORDLESS PAINT/MORTAR MIXER



	<b>TE-MX 18 Li - Solo</b> <b>EXPERT</b>
PXC battery voltage / capacity	18 V / -
Charging time	-
Idle speed	0 - 620 min <sup>-1</sup>
Stirrer mount	M14
Product weight	1.9 kg (excl. stirrer)
Speed control electronics	•
Soft start	•
Soft grip	•
Number of batteries / number of chargers	0 / 0
Accessories	1 mortar stirrer (Ø 100 mm)
Packaging	Colour box
Article number	42.587.60



# CORDLESS ANGLE GRINDERS

## ANTI-VIBRATION FUNCTION

for low-vibration operation

## OVERLOAD CUT-OUT

Protects the high-quality components and ensures long operation

## SOFT START FUNCTION AND RESTART SAFEGUARD

Provide even more safety for the user

## SPINDLE LOCK

Easy and quick disc change

## SLIMLINE DESIGN AND SOFT GRIP SURFACES

for safe and comfortable operation

## TURNABLE MAIN HANDLE

High safety and better handling when cutting

## ADDITIONAL HANDLE

Can be fitted in 2 different positions – for both left-handed and right-handed users

## DISC GUARD WITH QUICK ADJUST FACILITY

Quick adjustment to the working position without any tools

## POWER X-CHANGE LITHIUM-ION BATTERY

The rechargeable battery can be used in all the devices from the Power X-Change family

## BRUSHLESS MOTOR

More power and prolonged operation

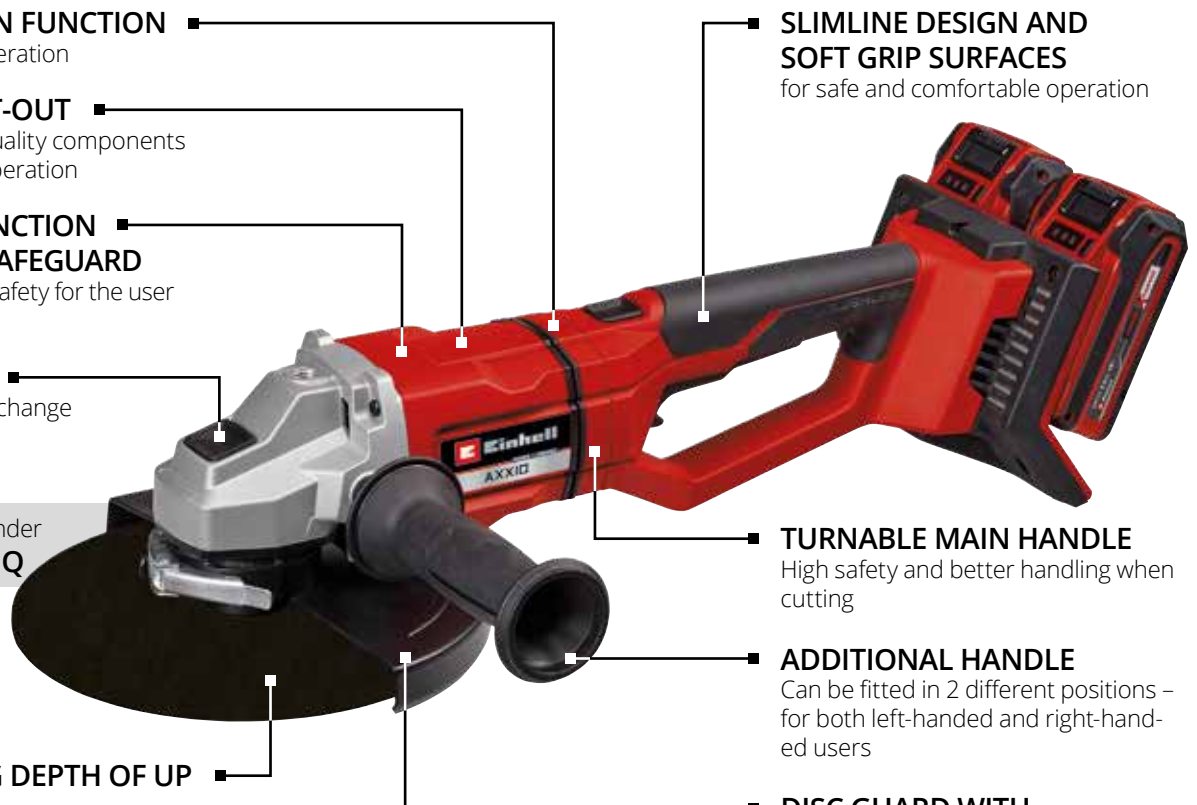

Cordless Angle Grinder  
AXXIO 36/230 Q

## LARGE CUTTING DEPTH OF UP TO 70 MM

for a wide range of applications

## CORDLESS ANGLE GRINDER 230 MM



	AXXIO 36/230 Q <b>PROFESSIONAL</b>	NEW
PXC battery voltage / capacity	2x 18 V / -	
Charging time	-	
Idle speed	6300 min <sup>-1</sup>	
Wheel diameter	230 mm	
Max. cutting depth	70 mm	
Product weight	4.0 kg (excl. battery)	
Brushless motor	•	
Soft start	•	
Restart safeguard	•	
Overload cut-out	•	
Disc guard with quick adjust facility	•	
Spindle Lock	•	
Soft grip	•	
Additional handle	can be mounted in 2 positions	
Number of batteries / number of chargers	0 / 0	
Accessories	Quick fix nut	
Packaging	Colour box	
Article number	44.311.60	



## CORDLESS ANGLE GRINDER 150 MM



BRUSHLESS ENERGY



<b>AXXIO 18/150</b> <b>PROFESSIONAL</b>	
PXC battery voltage / capacity	18 V / -
Charging time	-
Idle speed	8500 min <sup>-1</sup>
Wheel diameter	150 mm
Max. cutting depth	40 mm
Product weight	1.5 kg (excl. battery)
Brushless motor	•
Soft start	•
Restart safeguard	•
Overload cut-out	•
Disc guard with quick adjust facility	•
Spindle Lock	•
Soft grip	•
Additional handle	can be mounted in 2 positions
Number of batteries / number of chargers	0 / 0
Accessories	1 cutting wheel, 1 cutting wheel guard, 1 face spanner
Packaging	Colour box
Article number	44.311.44



## CORDLESS ANGLE GRINDER 125 MM



BRUSHLESS ENERGY



<b>AXXIO 18/125</b> <b>PROFESSIONAL</b>	
PXC battery voltage / capacity	18 V / -
Charging time	-
Idle speed	8500 min <sup>-1</sup>
Wheel diameter	125 mm
Max. cutting depth	33 mm
Product weight	1.4 kg (excl. battery)
Brushless motor	•
Soft start	•
Restart safeguard	•
Overload cut-out	•
Disc guard with quick adjust facility	•
Spindle Lock	•
Soft grip	•
Additional handle	can be mounted in 2 positions
Number of batteries / number of chargers	0 / 0
Accessories	Face spanner
Packaging	Colour box
Article number	44.311.40



## CORDLESS ANGLE GRINDERS 115 MM



BRUSHLESS ENERGY



Illustration similar

	<b>AXXIO 18/115 Q</b> <b>PROFESSIONAL</b>	<b>TE-AG 18/115 Q Li - Solo</b> <b>EXPERT</b> <span style="float: right;"><b>NEW</b></span>
PXC battery voltage / capacity	18 V / -	18 V / -
Charging time	-	-
Idle speed	8500 min <sup>-1</sup>	8500 min <sup>-1</sup>
Wheel diameter	115 mm	115 mm
Max. cutting depth	28 mm	28 mm
Product weight	1.2 kg (excl. battery)	1.2 kg (excl. battery)
Brushless motor	•	-
Soft start	•	•
Restart safeguard	•	•
Overload cut-out	•	•
Disc guard with quick adjust facility	•	•
Spindle Lock	•	•
Soft grip	•	•
Additional handle	can be mounted in 2 positions	can be mounted in 2 positions
Number of batteries / number of chargers	0 / 0	0 / 0
Accessories	Quick fix nut	Quick fix nut
Packaging	Colour box	Colour box
Article number	44.311.50	44.311.65



## CORDLESS ANGLE GRINDERS 115 MM



	<b>TE-AG 18/115 Li - Solo</b> <b>EXPERT</b>	<b>TE-AG 18/115 Li - Solo Acc</b> <b>EXPERT</b>
PXC battery voltage / capacity	18 V / -	18 V / -
Charging time	-	-
Idle speed	8500 min <sup>-1</sup>	8500 min <sup>-1</sup>
Wheel diameter	115 mm	115 mm
Max. cutting depth	28 mm	28 mm
Product weight	1.2 kg (excl. battery)	1.2 kg (excl. battery)
Brushless motor	-	-
Soft start	•	•
Restart safeguard	•	•
Overload cut-out	•	•
Disc guard with quick adjust facility	•	•
Spindle Lock	•	•
Soft grip	•	•
Additional handle	can be mounted in 3 positions	can be mounted in 3 positions
Number of batteries / number of chargers	0 / 0	0 / 0
Accessories	Face spanner	1 cutting wheel, 1 grinding wheel, 1 cutting wheel guard, 1 face spanner
Packaging	Colour box	E-Box Basic
Article number	44.311.10	44.311.23



# CORDLESS ANGLE GRINDERS 115 MM



	<b>TE-AG 18/115 Li (1x 4.0 Ah)</b> <b>EXPERT</b> <span style="float: right;"><b>NEW</b></span>	<b>TC-AG 18/115 Li - Solo</b> <b>CLASSIC</b>
PXC battery voltage / capacity	18 V / 4.0 Ah	18 V / -
Charging time	80 min	-
Idle speed	8500 min <sup>-1</sup>	8500 min <sup>-1</sup>
Wheel diameter	115 mm	115 mm
Max. cutting depth	28 mm	28 mm
Product weight	1.2 kg (excl. battery)	1.2 kg (excl. battery)
Brushless motor	•	-
Soft start	•	•
Restart safeguard	•	•
Overload cut-out	•	•
Disc guard with quick adjust facility	•	-
Spindle Lock	•	•
Soft grip	•	•
Additional handle	can be mounted in 3 positions	can be mounted in 3 positions
Number of batteries / number of chargers	1 / 1x Power X-Charger 3 A	0 / 0
Accessories	1 cutting wheel, 1 grinding wheel, 1 cutting wheel guard, 1 face spanner	Face spanner
Packaging	Einhell Bag 45/22	Colour box
Article number	44.311.34	44.311.30





# CORDLESS ROUTERS

**POWER X-CHANGE**

**LITHIUM-ION BATTERY**

The rechargeable battery can be used in all the devices from the Power X-Change family

**ROUTING DEPTH**

**ADJUSTMENT**

The routing depth is easy to preselect using the turret stop and can also be exactly adjusted using the precision depth adjustment facility

Cordless Router / Palm Router  
**TP-RO 18 SET Li BL**



**ELECTRONIC SPEED CONTROL**

Using the electronic speed control, operation of the router can be adapted with optimum effect to the particular requirements of the material and cutter used

**TWO-HAND ATTACHMENT**

enables precise operation of the unit

**CHIP SHIELD**

The transparent chip guard offers protection from flying chips in the field of view of the user

**CLAMP WITH 6 AND 8 MM**

The clamp creates flexibility by permitting the use of cutters with a shaft diameter of 6 mm or 8 mm

Illustration similar

## CORDLESS ROUTER/ PALM ROUTER



Illustration similar

**SPINDLE LOCK**

For quick and effortless tool change there is a spindle lock

**LED**

for optimum illumination of the work area

	<b>TP-RO 18 Set Li BL - Solo</b>
	<b>PROFESSIONAL</b> <span style="float: right;"><b>NEW</b></span>
PXC battery voltage / capacity	18 V / -
Charging time	-
Idle speed	10000 - 30000 min <sup>-1</sup>
Stroke height	40 mm / 35 mm
Max. form cutter	30 mm
Product weight	1.3 kg (palm router) / 2.4 kg (two-hand router) - each without a battery
Speed control electronics	•
Cutting depth fine adjustment	•
Chip shield	•
Spindle Lock	•
Soft grip	•
Dust extraction	•
Parallel stop	•
Compass point	•
Attachment	Palm router + two-hand attachment
Clamp diameter	6 mm / 8 mm
Storage case	•
Packaging	Colour box
Article number	43.504.10



## CORDLESS ROUTER



Illustration similar

	<b>TP-RO 18 Li BL - Solo</b> <b>PROFESSIONAL</b> <span style="float: right;"><b>NEW</b></span>
PXC battery voltage / capacity	18 V / -
Charging time	-
Idle speed	10000 - 30000 min <sup>-1</sup>
Stroke height	35 mm
Max. form cutter	30 mm
Product weight	2.4 kg (excl. battery)
Speed control electronics	•
Cutting depth fine adjustment	•
Chip shield	•
Spindle Lock	•
Soft grip	•
Dust extraction	•
Parallel stop	•
Compass point	•
Attachment	Two-hand attachment
Clamp diameter	6 mm / 8 mm
Storage case	-
Packaging	Colour box
Article number	43.504.11



4 006825 664263

## CORDLESS PALM ROUTER



Illustration similar

	<b>TP-ET 18 Li BL - Solo</b> <b>PROFESSIONAL</b> <span style="float: right;"><b>NEW</b></span>
PXC battery voltage / capacity	18 V / -
Charging time	-
Idle speed	10000 - 30000 min <sup>-1</sup>
Stroke height	40 mm
Max. form cutter	30 mm
Product weight	1.3 kg (excl. battery)
Speed control electronics	•
Cutting depth fine adjustment	•
Chip shield	•
Spindle Lock	•
Soft grip	•
Dust extraction	•
Parallel stop	•
Compass point	•
Attachment	Palm router
Clamp diameter	6 mm / 8 mm
Storage case	-
Packaging	Colour box
Article number	43.504.12



4 006825 664300

## CORDLESS BISCUIT JOINER



	TE-BJ 18 Li - Solo
	<b>EXPERT</b> <span style="float: right;"><b>NEW</b></span>
PXC battery voltage / capacity	18 V / -
Charging time	-
Idle speed	6500 min <sup>-1</sup>
Max. cutting depth	20 mm
Tilt angle adjustment	90°
Channel cutter	Ø 100 x Ø 22 x 4 mm
Product weight	2.2 kg (excl. battery)
Infinitely adjustable angle setting	•
Infinitely adjustable height	•
Cutting depth quick-set adjustment	6-stufig
Spindle Lock	•
Dust extraction	•
Face spanner	•
Packaging	Colour box
Article number	43.506.30



## CORDLESS PLANER



	TE-PL 18/82 Li - Solo
	<b>EXPERT</b>
PXC battery voltage / capacity	18 V / -
Charging time	-
Idle speed	15000 min <sup>-1</sup>
Planing width	82 mm
Chip depth	2 mm
Rebate depth	8 mm
Product weight	2.4 kg (excl. battery)
Soft grip	•
Automatic blade protector	•
Aluminium sole plates	•
V grooves	1
Chip ejection	on one side
Number of batteries / number of chargers	0 / 0
Parallel stop	•
Rebate depth stop	•
Planing blades (reversible blades)	1 pair TCT
Packaging	Colour box
Article number	43.454.00



## CORDLESS JIGSAWS



	<b>TE-JS 18/80 Li - Solo</b> <b>EXPERT</b>
PXC battery voltage / capacity	18 V / -
Charging time	-
Stroke speed	0 - 2400 min <sup>-1</sup>
Cutting depth (wood/plastic/steel)	80 / 12 / 10 mm
Product weight	1.8 kg (excl. battery)
Universal blade holder	•
Pendulum action	4 settings
Cutting angle adjustment without tools	•
Blade change without tools	•
Vacuum cleaner connection	•
LED	•
Dust-blower function	•
Cutting line guide	•
Number of batteries / number of chargers	0 / 0
Accessories	Parallel stop, chip guard
Packaging	Colour box
Article number	43.212.00



## CORDLESS JIGSAWS



	<b>TC-JS 18 Li - Solo</b> <b>CLASSIC</b>	<b>TC-JS 18 Li (1x 2.5 Ah)</b> <b>CLASSIC</b> <span style="float: right;"><b>NEW</b></span>
PXC battery voltage / capacity	18 V / -	18 V / 2.5 Ah
Charging time	-	50 min
Stroke speed	0 - 2700 min <sup>-1</sup>	0 - 2700 min <sup>-1</sup>
Cutting depth (wood/plastic/steel)	70 / 10 / 8 mm	70 / 10 / 8 mm
Product weight	1.8 kg (excl. battery)	1.8 kg (excl. battery)
Universal blade holder	-	-
Pendulum action	4 settings	4 settings
Cutting angle adjustment without tools	-	-
Blade change without tools	•	•
Vacuum cleaner connection	•	•
LED	-	-
Dust-blower function	•	•
Cutting line guide	-	-
Number of batteries / number of chargers	0 / 0	1 / 1x Power X-Charger 3 A
Accessories	1x high quality kwb saw blade, chip guard	3x kwb saw blade (wood), 2x kwb saw blade (metal), chip guard
Packaging	Colour box	E-Box Basic
Article number	43.212.09	43.212.28



**CORDLESS CIRCULAR SAWS**



BRUSHLESS ENERGY



PROFESSIONAL  
TESTING

	<b>TP-CS 18/190 Li BL - Solo</b> <b>PROFESSIONAL</b>
PXC battery voltage / capacity	18 V / -
Charging time	-
Idle speed	3800 min <sup>-1</sup>
Saw blade	Ø 190 x Ø 20/30 mm
Cutting depth 90°	65 mm
Cutting depth 45°	45 mm
Product weight	3.2 kg (excl. battery)
Brushless motor	•
Adjustment without tools (depth/angle)	•
LED	•
Aluminium sawing table	•
Spindle Lock	•
Double-sided safety lock-off	•
Dust extraction device	•
Soft grip	•
Number of batteries / number of chargers	0 / 0
Accessories	Parallel stop
Packaging	Colour box
Article number	43.312.10



**CORDLESS CIRCULAR SAWS**



EXPERT  
TESTING

	<b>TE-CS 18/165-1 Li - Solo</b> <b>EXPERT</b>
PXC battery voltage / capacity	18 V / -
Charging time	-
Idle speed	4200 min <sup>-1</sup>
Saw blade	Ø 165 x Ø 20 mm
Cutting depth 90°	54 mm
Cutting depth 45°	35 mm
Product weight	2.6 kg (excl. battery)
Brushless motor	-
Adjustment without tools (depth/angle)	•
LED	•
Aluminium sawing table	•
Spindle Lock	•
Double-sided safety lock-off	•
Dust extraction device	•
Soft grip	•
Number of batteries / number of chargers	0 / 0
Accessories	Parallel stop
Packaging	Colour box
Article number	43.312.07



	<b>TE-CS 18/150 Li - Solo</b> <b>EXPERT</b>
PXC battery voltage / capacity	18 V / -
Charging time	-
Idle speed	4200 min <sup>-1</sup>
Saw blade	Ø 150 x Ø 10/16 mm
Cutting depth 90°	48 mm
Cutting depth 45°	32 mm
Product weight	2.4 kg (excl. battery)
Brushless motor	-
Adjustment without tools (depth/angle)	•
LED	•
Aluminium sawing table	•
Spindle Lock	•
Double-sided safety lock-off	•
Dust extraction device	•
Soft grip	•
Number of batteries / number of chargers	0 / 0
Accessories	Parallel stop
Packaging	Colour box
Article number	43.312.20



# CORDLESS MINI CIRCULAR SAW



	<b>TE-CS 18/89 Li - Solo</b> <b>EXPERT</b>
PXC battery voltage / capacity	18 V / -
Charging time	-
Idle speed	3500 min <sup>-1</sup>
Saw blade	Ø 89 x Ø 10 mm
Cutting depth 90°	28 mm
Product weight	1.8 kg (excl. battery)
Brushless motor	-
Adjustment without tools (depth)	•
LED	-
Aluminium sawing table	•
Spindle Lock	•
Double-sided safety lock-off	-
Dust extraction device	•
Soft grip	•
Number of batteries / number of chargers	0 / 0
Accessories	2 saw blades (wood/plastic), parallel stop
Packaging	Colour box
Article number	43.311.00



**CORDLESS ALL PURPOSE SAWS**

BRUSHLESS ENERGY



LOW WEIGHT EASY HANDLING

	<b>TP-AP 18/28 Li BL - Solo</b> <b>PROFESSIONAL</b>
PXC battery voltage / capacity	18 V / -
Charging time	-
Stroke speed	0 - 2500 min <sup>-1</sup>
Stroke height	28 mm
Cutting depth (wood / steel)	200 / 12 mm
Saw blade thickness	0.8 - 1.6 mm
Product weight	2.0 kg (excl. battery)
Brushless motor	•
Blade change without tools	•
Soleplate adjustment without tools	•
Anti-vibration function	•
Rotatable main handle	•
Number of batteries / number of chargers	0 / 0
Accessories	1 kwb saw blade
Packaging	Colour box
Article number	43.263.10



**CORDLESS ALL PURPOSE SAWS**

LOW WEIGHT EASY HANDLING



	<b>TE-AP 18/26 Li - Solo</b> <b>EXPERT</b>	<b>NEW</b>	<b>TE-AP 18/22 Li - Solo</b> <b>EXPERT</b>
PXC battery voltage / capacity	18 V / -		18 V / -
Charging time	-		-
Stroke speed	0 - 2600 min <sup>-1</sup>		0 - 2600 min <sup>-1</sup>
Stroke height	26 mm		22 mm
Cutting depth (wood / steel)	180 / 12 mm		100 / 6 mm
Saw blade thickness	0.7 - 1.8 mm		0.6 - 1.6 mm
Product weight	2.0 kg (excl. battery)		1.6 kg (excl. battery)
Brushless motor	-		-
Blade change without tools	•		•
Soleplate adjustment without tools	•		•
Anti-vibration function	•		-
Rotatable main handle	-		-
Number of batteries / number of chargers	0 / 0		0 / 0
Accessories	1 saw blade (wood)		1 saw blade (wood)
Packaging	Colour box		Colour box
Article number	43.262.90		43.263.00



## CORDLESS SLIDING MITRE SAW



TE-SM 36/210 Li - Solo	
<b>EXPERT</b>	
PXC battery voltage / capacity	2x 18 V / -
Speed	3800 min <sup>-1</sup>
Saw blade	Ø 210 x Ø 30 mm
Number of teeth	40
Swivelling range	-47° to +47°
Mitre cut	0° to 45° to the left
Max. cutting capacity at 90°	310 x 65 mm
Product weight	12.6 kg (excl. battery)
Laser	•
LED light	•
Soft start	•
Overload cut-out	•
X-Tend support with limit stop	•
Clamping device	•
Number of batteries / number of chargers	0 / 0
Precision TCT saw blade	1 pc
Sawdust bag	•
Article number	43.008.80



## CORDLESS MITRE SAW



TE-MS 18/210 Li - Solo	
<b>EXPERT</b>	
PXC battery voltage / capacity	18 V / -
Speed	3000 min <sup>-1</sup>
Saw blade	Ø 210 x Ø 30 mm
Number of teeth	40
Swivelling range	-47° to +47°
Mitre cut	0° to 45° to the left
Max. cutting capacity at 90°	120 x 60 mm
Product weight	7.8 kg (excl. battery)
Laser	•
LED light	•
Soft start	•
Overload cut-out	•
X-Tend support with limit stop	•
Clamping device	•
Number of batteries / number of chargers	0 / 0
Precision TCT saw blade	1 pc
Sawdust bag	•
Article number	43.008.90





## CORDLESS TABLE SAW

**TWIN-PACK®**  
 18V + 18V **36V**  
 TECHNOLOGY



	<b>TE-TS 36/210 Li - Solo</b> <b>EXPERT</b>
PXC battery voltage / capacity	2x 18 V / -
Speed	3800 min <sup>-1</sup>
Saw blade	Ø 210 x Ø 30 mm
Number of teeth	40
Mitre cut	0° to 45° to the left
Cutting height 90°	70 mm
Cutting height 45°	45 mm
Bench size	467 x 480 mm
Max. cutting capacity on the right	625 mm
Product weight	13.1 kg (excl. battery)
Table extension	right, pull-out
Soft start	•
Overload cut-out	•
Number of batteries / number of chargers	0 / 0
Precision TCT saw blade	1 pc
Parallel stop, clamped on both sides	•
Angle stop	•
Push stick	•
Article number	43.404.50



## CORDLESS BAND SAWS



Illustration similar



Illustration similar

	<b>TE-MB 18/127 U Li - Solo</b> <b>EXPERT</b> <b>NEW</b>	<b>TE-MB 18/127 Li - Solo</b> <b>EXPERT</b> <b>NEW</b>
PXC battery voltage / capacity	18 V / -	18 V / -
Speed	0 - 120 min <sup>-1</sup>	0 - 120 min <sup>-1</sup>
Number of speed settings	variable with 6 settings	variable with 6 settings
Saw Band	1141 x 13 x 0.65 mm	1141 x 13 x 0.65 mm
Number of teeth	10/14 combination teeth	10/14 combination teeth
Mitre cut	0° to 45° to the left	-
Max. cutting capacity at 90°	127 x 127 mm	127 x 127 mm
Max. cutting capacity at 45°	45 x 45 mm	-
Product weight	13.0 kg (excl. battery)	5.8 kg (excl. battery)
Work table removable	•	•
Constant electronics	•	•
Blade change without tools	•	•
Handle adjustable without tools	•	•
LED	•	•
Work bench with quick clamping mechanism	•	-
Number of batteries / number of chargers	0 / 0	0 / 0
Accessories	2x 10/14 T saw bands	2x 10/14 T saw bands
Work table	•	-
Article number	45.042.15	45.042.16



## CORDLESS MULTIFUNCTIONAL TOOLS



	<b>VARRITO</b> <b>EXPERT</b>	<b>TC-MG 18 Li - Solo</b> <b>CLASSIC</b>
PXC battery voltage / capacity	18 V / -	18 V / -
Charging time	-	-
Oscillating speed / idle speed	22000 - 40000 min <sup>-1</sup> / 11000 - 20000 min <sup>-1</sup>	22000 - 40000 min <sup>-1</sup> / 11000 - 20000 min <sup>-1</sup>
Oscillation angle	3.2°	3.2°
Abrasive paper size	93 x 93 x 93 mm	93 x 93 x 93 mm
Product weight	1.0 kg (excl. battery)	0.9 kg (excl. battery)
Speed control electronics	•	•
Soft grip	•	•
Quick-release lock	•	-
Magnetic tool mounting	•	•
Oscillation decoupled battery uptake	•	•
Number of batteries / number of chargers	0 / 0	0 / 0
Delta grinding/sanding disc	•	•
Abrasive paper	3x P60, 3x P80, 3x P120	3x P60, 3x P80, 3x P120
Scraper	•	•
Plunge-cut blades	1x wood/plastic, 1x metal	1x wood/plastic
Segment saw blades	Wood/plastic/non-ferrous metal, tile joints (1x each)	1x wood/plastic/non-ferrous metal
Hex key	-	•
Packaging	Colour box	Colour box
Article number	44.651.60	44.651.70



4 006825 618648



4 006825 628593

## CORDLESS DRYWALL POLISHER



	<b>TP-DW 18/225 Li - Solo</b> <b>PROFESSIONAL</b>
PXC battery voltage / capacity	18 V / -
Idle speed	600 - 1200 min <sup>-1</sup>
Abrasive paper dimensions, Ø	225 mm
Device length	110 - 165 cm
Hose length	2.0 m
Product weight	3.6 kg (excl. battery)
Turnable sanding disc	•
Speed control electronics	•
Hook and loop fastening system	•
Folding and height-adjustable long handle	•
Supporting foot	•
Number of batteries / number of chargers	0 / 0
Abrasive paper	2x P60, 2x P80, 2x P120 + abrasive mesh P120
Dust bag	•
Packaging	E-Box
Article number	42.599.90



4 006825 647037

## CORDLESS BAND SANDER



Illustration similar

	TP-BS 18/457 Li BL - Solo <b>PROFESSIONAL</b>
PXC battery voltage / capacity	18 V / -
Grinding/sanding belt speed	120 - 250 m/min
Grinding/sanding area	75 x 126
Grinding/sanding belt size	75 x 457
Product weight	2.5 kg
Brushless motor	•
Belt run adjustment	•
Belt change without tools	•
Dust extraction	by use of dust bag + dust extraction adapter
Soft grip	•
Number of batteries / number of chargers	0 / 0
Sanding/grinding belt	3x P80
Packaging	Colour box
Article number	44.662.70



4 006825 663624

## CORDLESS ORBITAL SANDERS



	TE-OS 18/230 Li - Solo <b>EXPERT</b>	TC-OS 18/187 Li - Solo <b>CLASSIC</b>
PXC battery voltage / capacity	18 V / -	18 V / -
Oscillating speed	14000 - 22000 min <sup>-1</sup>	24000 min <sup>-1</sup>
Oscillating circuit, Ø	2.5 mm	2.0 mm
Abrasive paper size	230 x 115 mm	187 x 94 mm
Product weight	1.6 kg (excl. battery)	1.1 kg (excl. battery)
Speed control electronics	•	-
Hook and loop fastening system	•	•
Clamping mechanism	•	•
Soft grip	•	•
Dust extraction	by use of dust bag + dust extraction adapter	by use of dust bag + dust extraction adapter
Number of batteries / number of chargers	0 / 0	0 / 0
Abrasive paper	1x P60, 1x P80, 1x P120	1x P80
Dust extraction adapter	•	•
Packaging	Colour box	Colour box
Article number	44.607.20	44.607.25



4 006825 642728



4 006825 642735

## CORDLESS MULTI SANDER



	<b>TE-OS 18/150 Li - Solo</b> <b>EXPERT</b>
PXC battery voltage / capacity	18 V / -
Oscillating speed	24000 min <sup>-1</sup>
Oscillating circuit, Ø	1.6 mm
Abrasive paper size	150 x 150 x 100 mm
Product weight	0.8 kg (excl. battery)
Speed control electronics	-
Hook and loop fastening system	•
Clamping mechanism	-
Soft grip	•
Dust extraction	by use of dust collection box & dust extraction adapter
Number of batteries / number of chargers	0 / 0
Abrasive paper	3x P120, 3x P240
Dust extraction adapter	•
Packaging	Colour box
Article number	44.607.08



4 006825 651218

## CORDLESS ROTATING SANDER



	<b>TE-RS 18 Li - Solo</b> <b>EXPERT</b>
PXC battery voltage / capacity	18 V / -
Oscillating speed	14000 - 22000 min <sup>-1</sup>
Oscillating circuit, Ø	2.0 mm
Abrasive paper, Ø	125 mm
Product weight	1.2 kg (excl. battery)
Speed control electronics	•
Hook and loop fastening system	•
Dust extraction	by use of dust bag + dust extraction adapter
Soft grip	•
Number of batteries / number of chargers	0 / 0
Abrasive paper	1x P80
Packaging	Colour box
Article number	44.620.10



4 006825 618341

## CORDLESS POLISHING/ SANDING MACHINE



	<b>CE-CP 18/180 Li E - Solo</b> <b>EXPERT</b>
PXC battery voltage / capacity	18 V / -
Idle speed	500 - 3000 min <sup>-1</sup>
Diameter	180 mm
Product weight	1.3 kg (excl. battery)
Brushless motor	•
Suitable for grinding	•
ON/OFF switch	•
Ergonomic soft grip	•
Speed control electronics	•
Spindle Lock	•
Hook and loop fastener for polishing/grinding acc.	•
Number of batteries / number of chargers	0 / 0
Synthetic bonnet	1 pc
Foam pad	1 pc
Abrasive paper (grit size 60, 80, 120)	1 of each
Packaging	Colour box
Article number	20.933.20



## CORDLESS CAR POLISHING MACHINE



	<b>CE-CB 18/254 Li - Solo</b> <b>CAR EXPERT</b>
PXC battery voltage / capacity	18 V / -
Idle speed	2500 min <sup>-1</sup>
Diameter	254 mm
Product weight	1.9 kg (excl. battery)
ON/OFF switch	•
Ergonomic soft grip	•
Number of batteries / number of chargers	0 / 0
Textile bonnet	1 pc
Synthetic bonnet	1 pc
Packaging	Colour box
Article number	20.933.01



## CORDLESS NAILER



	<b>TE-CN 18 Li - Solo</b> <b>EXPERT</b>
PXC battery voltage / capacity	18 V / -
Shots per minute	20 min <sup>-1</sup>
Staple length	16 - 22 mm
Nail length	15 - 32 mm
Product weight	2.1 kg (excl. battery)
Cutting depth adjustment	•
Magazine with level indicator	•
Belt clip	•
Trigger catch	•
Soft grip	•
Number of batteries / number of chargers	0 / 0
Nails	300 pcs
Staples	300 pcs
Packaging	Colour box
Article number	42.577.90



## CORDLESS SEALING GUN



	<b>TE-SG 18/28 Li - Solo</b> <b>EXPERT</b> <b>NEW</b>
PXC battery voltage / capacity	18 V / -
Dispensing speed	0 - 26 mm/s
Dispensing force	2000 N
Inner diameter	51 mm
Cartridge volume	310 ml
Product weight	1.9 kg (excl. battery)
Brushless motor	-
Adjustable dispensing speed	•
Automatic reversing mechanism	•
Rubber pads	•
Soft grip	•
Number of batteries / number of chargers	0/0
Accessories	Cleaning needle
Packaging	Colour box
Article number	45.222.50



## CORDLESS PAINT SPRAY SYSTEM



	<b>TC-SY 18/60 Li - Solo</b> <b>CLASSIC</b>
PXC battery voltage / capacity	18 V / -
Charging time	-
Delivery rate	650 ml/min
Tank volume	800 ml
Max. viscosity	60 DIN-sec
Product weight	1.3 kg (excl. battery)
Brushless motor	-
Processing	Lacquers, glazes
Removable spray cap	•
Control of the paint delivery rate	•
Paint jet	Vertical, horizontal and round jet
Soft grip	•
Spray nozzles	Ø 2.0 mm, 2.5 mm
Cleaning brush and needle	•
Tank for testing the viscosity	•
Paint tank with cover	800 ml
Packaging	Colour box
Article number	42.600.25



## CORDLESS RADIO



	<b>TC-RA 18 Li BT - Solo</b> <b>CLASSIC</b>
PXC battery voltage / capacity	18 V / -
FM Frequency	87.5 - 108 MHz
AM Frequency	522 - 1620 kHz
Station memory (AM/FM)	10 / 10
Product weight	0.7 kg (excl. battery)
Hybrid function	-
LCD display	•
External antenna	•
Bluetooth	•
AUX connection	-
USB charging function	-
Carry handle	•
Storage room at the back for a mobile phone etc.	•
Number of batteries / number of chargers	0 / 0
Packaging	Colour box
Article number	34.080.17



## CORDLESS SPEAKER



	<b>TC-SR 18 Li BT - Solo</b> <b>CLASSIC</b>
PXC battery voltage / capacity	18 V / -
Power rating	2x 3.0 W
Max. volume	85 dB
Product weight	0.3 kg (excl. battery)
AUX connection	•
Bluetooth	•
USB charging function	•
Number of batteries / number of chargers	0 / 0
Packaging	Carton with window
Article number	45.141.50



## CORDLESS LIGHTS



	<b>TE-CL 18/2500 LiAC - Solo</b> <b>EXPERT</b>	<b>TE-CL 18/2000 LiAC - Solo</b> <b>EXPERT</b>	<b>TC-CL 18/1800 Li - Solo</b> <b>CLASSIC</b>
PXC battery voltage / capacity	18 V / -	18 V / -	18 V / -
Mains connection	12 V	100 - 240 V ~ 50-60 Hz	-
Cable length	3 m	2 m	-
Luminosity	1000 lm / 2500 lm	1000 lm / 1500 lm / 2000 lm	1800 lm
Light source	7 LED	20 LED	1 LED
Light ON time	3 h (4.0 Ah)	4 h (4.0 Ah)	4 h (4.0 Ah)
Product weight	0.6 kg (excl. battery)	1.3 kg (excl. battery)	1.3 kg (excl. battery)
Angle adjustment	-	•	•
Adjustable light beam	-	-	-
Fastening hooks	-	•	•
Tripod socket	1/4"	1/4" / 5/8"	-
Soft grip	•	•	-
Number of batteries / number of chargers	0 / 0	0 / 0	0 / 0
Packaging	Colour box	Colour box	Colour box
Article number	45.141.45	45.141.14	45.141.15



## CORDLESS LIGHTS



	<b>TC-CL 18 Li H - Solo</b> <b>CLASSIC</b>
PXC battery voltage / capacity	18 V / -
Mains connection	-
Cable length	-
Luminosity	280 lm
Light source	1 LED
Light ON time	8 h (1.5 Ah)
Product weight	0.2 kg (excl. battery)
Angle adjustment	•
Adjustable light beam	-
Fastening hooks	-
Tripod socket	-
Soft grip	•
Number of batteries / number of chargers	0 / 0
Packaging	Colour box
Article number	45.141.30



## USB BATTERY ADAPTER



	<b>TC-CP 18 Li USB - Solo</b> <b>CLASSIC</b>
PXC battery voltage / capacity	18 V / -
USB connections	2
Output current USB 1	1.0 A
Output current USB 2	2.1 A
Product weight	0.1 kg (excl. battery)
Number of batteries / number of chargers	0 / 0
Packaging	Colour box
Article number	45.141.20





## CORDLESS BLOWER



	<b>TE-CB 18/180 Li - Solo</b> <b>EXPERT</b>
PXC battery voltage / capacity	18 V / -
Blowing air flow step 1   step 2	130 km/h   180 km/h
Product weight	1.0 kg (excl. battery)
Number of batteries / number of chargers	0 / 0
Inflation nozzles	3 pcs
Packaging	Colour box
Article number	34.080.01



4 006825 631746

## CORDLESS HOT GLUE GUN



	<b>TE-CG 18 Li - Solo</b> <b>EXPERT</b>
PXC battery voltage / capacity	18 V / -
Warm-up period	120 s
Max. temperature	170 °C
Glue sticks, Ø	11 mm
Product weight	0.3 kg (excl. battery)
LED heat level indicator	•
LED light	•
Number of batteries / number of chargers	0 / 0
Accessories	5 glue sticks (l = 200 mm), flat glue nozzle
Packaging	Colour box
Article number	45.222.00



4 006825 641202

## CORDLESS HOT AIR GUN



	<b>TE-HA 18 Li - Solo</b> <b>EXPERT</b>
PXC battery voltage / capacity	18 V / -
Temperature setting 1   setting 2	350 °C   550 °C
Air rate	200 l/min
Product weight	0.6 kg (excl. battery)
LED display	•
Overheating guard	•
Continuous operation setting	•
Mechanical nozzle ejector	•
Number of batteries / number of chargers	0 / 0
Reducer nozzle	•
Wide nozzle	•
Reflector nozzle	•
Packaging	Colour box
Article number	45.205.00



4 006825 647730

# SYSTEM CASES E-CASE

## E-CASE-SYSTEM

### CAN BE EQUIPPED WITH PADLOCK

To guard against theft, the E-Case can be equipped with a padlock

### LOCKING SYSTEM

The locking system for connecting stacked cases ensures easy storage and transport

### SPLASH-PROOF DESIGN

E-Cases are designed to keep out not only splash water but also dirt and dust in order to protect tools and accessories

### HIGH-QUALITY MATERIAL

The E-Case is made of polypropylene. That ensures heat resistance, stiffness and impact resistance

### COMPATIBILITY

All E-Case sizes are mutually compatible and interconnectable

### LABEL STICKER

So that you always know what's in the case

### STURDY FASTENERS

for closing the case securely

### FOLD-IN HANDLES

Carrying the case is comfortable thanks to two fold-in and ergonomic handles – one on the top and one on the side

System Case  
**E-CASE S-F**

### FOUR DEPRESSIONS IN THE LID

to prevent stacked cases from slipping

### OPTIONAL – PLASTIC COMPARTMENTS

Maximum flexibility for storing and transporting accessories such as screws, bits, etc.

## EASY STORAGE AND TRANSPORTATION



## WIDE RANGE OF APPLICATIONS



Art. N° 45.400.11



Art. N° 45.400.1 in combination with  
Art. N° 45.400.12



Art. N° 45.400.11 in combination with  
Art. N° 45.400.13

**SYSTEM CASES E-CASE**



	E-Case S-F	E-Case L <span style="float: right;">NEW</span>	E-Case Tower <span style="float: right;">NEW</span>
Items supplied	1x system case + 2x foam inserts for devices	1x E-Case L + 1x hand tool insert	1x E-Case S + 2x foam inlays, 1x E-Case S + 1x set of plastic compartments, 1x E-Case L + 1x hand tool insert, 9x plastic dividers
Internal dimensions	421 x 281 x 96 mm	421 x 273 x 320 mm	421 x 281 x 96 mm (E-Case S), 421 x 273 x 320 mm (E-Case L)
External dimensions	444 x 330 x 131 mm	444 x 410 x 360 mm	444 x 410 x 620 mm
Load capacity	25 kg	100 kg	100 kg
Product weight	1.7 kg	7.62 kg	11.4 kg
Stackable + locking system	•	•	•
Splash-proof	•	•	•
Lockable	•	•	•
Telescopic handle + wheels	-	•	•
Foam inserts	1x inlay for lid, 1x inlay for base	-	1x inlay for lid, 1x inlay for base
Plastic compartments	-	-	2x long, 3x mid-length, 4x short dividers
Hand tool insert	-	•	•
Article number	45.400.11	45.400.14	45.400.15



**E-CASES ACCESSORIES**



	Set of Plastic Compartments	Perforates foam <span style="float: right;">NEW</span>
Suitable for	E-Case S-F	E-Case S-F
Items supplied	2x long, 3x medium, 4x short dividers	1x adjustable perforated foam inlay
Article number	45.400.12	45.400.13



**UNMATCHED FOR RUGGEDNESS!**



**25 kg**

Maximum loading of a single case when carried by the handle on the side



**90 kg**

Maximum loading of several cases when carried by the broad handle on the top



**300 kg**

Concentrated loading from above – withstands the weight of one person without difficulty



**1000 kg**

Maximum permissible loading of the case at the bottom of the stack

## ACCESSORIES – CASES



	E-Box L70	E-Box M55	E-Box S35
Items supplied	1 universal case	1 universal case	1 universal case
Internal dimensions	670 x 190 x 300 mm	510 x 327 x 124 mm	310 x 250 x 89.5 mm
External dimensions	700 x 250 x 350 mm	550 x 400 x 150 mm	350 x 330 x 110 mm
Load capacity	50 kg	30 kg	12 kg
Product weight	4.1 kg	3.0 kg	1.6 kg
Stackable + locking system	-	-	-
Splash-proof	•	•	•
Lockable	-	-	-
Foam inserts	•	•	•
Plastic compartments	-	-	-
Article number	45.300.54	45.300.49	45.300.45



## ACCESSORIES – BAGS



	Einhell Bag 45/22	Einhell Bag 45/29 <span style="float: right; border: 1px solid red; padding: 2px;">NEW</span>
Items supplied	1 universal bag	1 universal bag
Internal dimensions	390 x 200 x 190 mm	420 x 270 x 200 mm
External dimensions	450 x 220 x 350 mm	450 x 290 x 220 mm
Load capacity	15 kg	20 kg
Product weight	0.9 kg	1.2 kg
Article number	45.300.37	45.300.74



# CORDLESS WET AND DRY VACUUM CLEANERS



Cordless Wet and Dry Vacuum Cleaner  
TP-VC 36/30 S Auto

## POWER X-CHANGE

### LITHIUM-ION BATTERY

Cordless operation means that corners and hard-to-reach areas are easy to sweep as well. The rechargeable battery can be used in all the devices from the Power X-Change family

## ECO/BOOST MODE

2 speeds (ECO + BOOST) for optimum battery use

## ACCESSORY HOLDER

The TP-VC 36/30 S Auto is always ready for action thanks to the accessory holder directly on the equipment

## TWIN-PACK®

18V + 18V = 36V

## TECHNOLOGY

## TWIN-PACK TECHNOLOGY

Using 2x 18 V Power X-Change rechargeable batteries delivers even more power

## HEAVY-DUTY SUCTION HOSE

The 2.50 m hose is flexible and resistant to foot traffic at the same time

## CONNECTIVITY FUNCTION

The connectivity function means that no cables are required to connect the vac. It starts up automatically when the cordless power tool is started

## STAINLESS STEEL TANK

The 30 l stainless steel tank provides sufficient capacity for dirt and liquids

## LARGE WHEELS AND CASTORS

Thanks to the 2 wheels and the 2 castors the wet and dry vacuum cleaner is easy to move about in the workshop, garage or living area

## CORDLESS WET AND DRY VACUUM CLEANERS



	TP-VC 36/30 S Auto - Solo <b>PROFESSIONAL</b>	TE-VC 36/30 Li S - Solo <b>EXPERT</b>
PXC battery voltage / capacity	2x 18 V / -	2x 18 V / -
Suction power	150 mbar / 100 mbar (BOOST / ECO)	150 mbar / 100 mbar (BOOST / ECO)
Tank	Stainless steel, 30 l	Stainless steel, 30 l
Suction hose length / diameter	250 cm / 36 mm	250 cm / 36 mm
Product weight	8.0 kg (excl. battery)	8.0 kg (excl. battery)
Automatic starting system	•	-
Speed settings	2	2
Heavy-duty suction hose	•	•
Number of batteries / number of chargers	0 / 0	0 / 0
Suction tube	Telescopic, stainless steel	Telescopic, stainless steel
Nozzles	Combination, crevice and upholstery nozzle (1x each)	Combination, crevice and upholstery nozzle (1x each)
Filters	Foam, pleated filter, dirt bag (1x each)	Foam, pleated filter, dirt bag (1x each)
Packaging	Colour box	Colour box
Article number	23.471.43	23.471.40



4 006825 660067



4 006825 635874

## CORDLESS WET AND DRY VACUUM CLEANERS



	<b>TE-VC 36/25 Li S - Solo</b> <b>EXPERT</b>	<b>TC-VC 18/20 Li S - Solo</b> <b>CLASSIC</b>
PXC battery voltage / capacity	2x 18 V / -	18 V / -
Suction power	150 mbar / 100 mbar (BOOST / ECO)	80 mbar
Tank	Stainless steel, 25 l	Stainless steel, 20 l
Suction hose length / diameter	250 cm / 36 mm	150 cm / 36 mm
Product weight	7.0 kg (excl. battery)	3.6 kg (excl. battery)
Automatic starting system	-	-
Speed settings	2	1
Heavy-duty suction hose	-	-
Number of batteries / number of chargers	0 / 0	0 / 0
Suction tube	2-piece, stainless steel	3-piece, plastic
Nozzles	Combination, crevice and upholstery nozzle (1x each)	Combination, crevice and upholstery nozzle (1x each)
Filters	Foam, pleated filter, dirt bag (1x each)	Foam, pleated filter, dirt bag (1x each)
Packaging	Colour box	Colour box
Article number	23.471.70	23.471.30



## CORDLESS WET AND DRY VACUUM CLEANERS



	<b>TC-VC 18/15 Li - Solo</b> <b>CLASSIC</b>	<b>TE-VC 18/10 Li - Solo</b> <b>EXPERT</b>
PXC battery voltage / capacity	18 V / -	18 V / -
Suction power	80 mbar	90 mbar
Tank	Plastic, 15 l	Plastic, 10 l
Suction hose length / diameter	150 cm / 36 mm	200 cm / 36 mm
Product weight	3.2 kg (excl. battery)	3.1 kg (excl. battery)
Automatic starting system	-	-
Speed settings	1	1
Heavy-duty suction hose	-	-
Number of batteries / number of chargers	0 / 0	0 / 0
Suction tube	3-piece, plastic	-
Nozzles	Combination, crevice nozzle (1x each)	2-in-1 crevice/brush nozzle, 2-in-1 upholstery/universal nozzle (1 of each)
Filters	Foam filter, filter bag, dirt bag (1x each)	Foam filter, filter bag, dirt bag (1x each)
Packaging	Colour box	Colour box
Article number	23.471.45	23.471.60



# CORDLESS STICK VAC CLEANER

## LIGHTWEIGHT DESIGN

for tireless working in and around the house

## 2-IN-1 FUNCTION

Usable as a hand vacuum as well as perfect handling when cleaning floors as a cordless stick vacuum cleaner

## HIGH SPEED CHARGING TECHNOLOGY

Short charging times and uninterrupted operation

## CORDLESS, BUT UNLIMITED RUNTIME

thanks to the Power X-Change interchangeable battery system

## POWER BRUSH WITH 2 SETTINGS

Adjustment to every situation in just two steps, ECO for handling normal dirt load with maximum running time, BOOST for handling stubborn dirt load with maximum suction, e.g. on carpets

## CORDLESS STICK VAC CLEANER

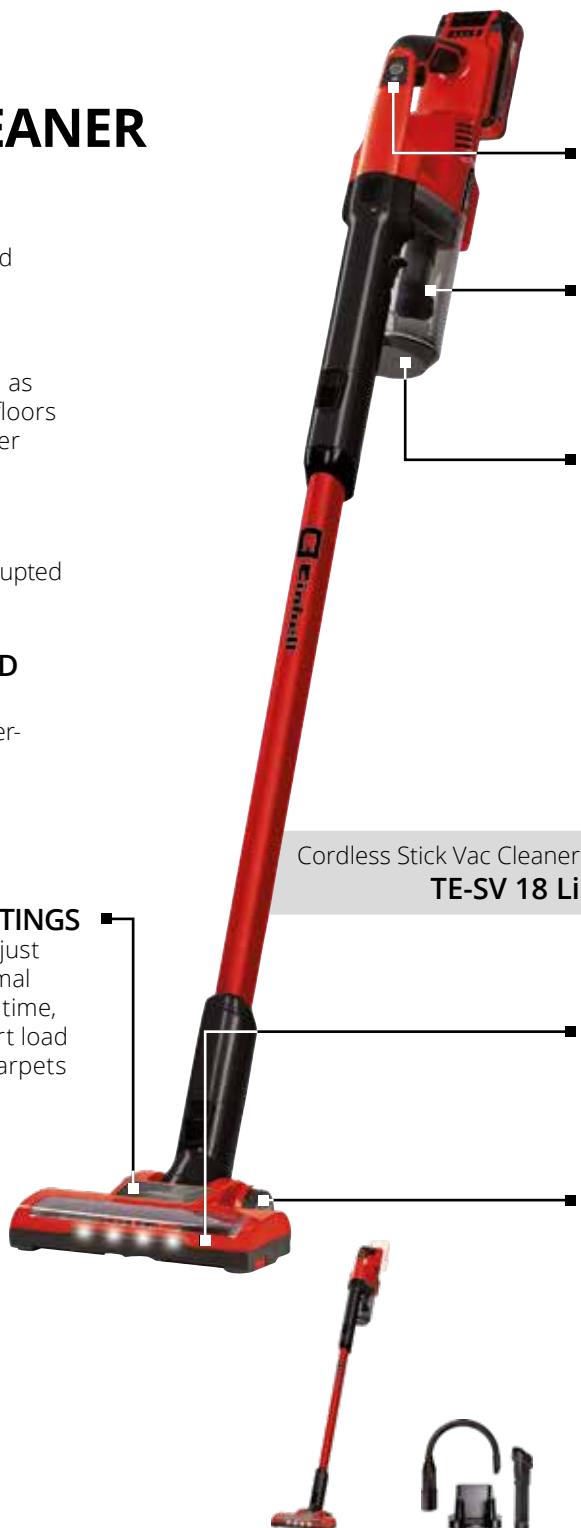

Cordless Stick Vac Cleaner  
TE-SV 18 Li

### ECO AND BOOST MODE

Suction power adjustment to every situation

### BAG-FREE EMPTYING

Easy bag-free emptying by pushbutton protects the environment, cuts cost and is also highly hygienic by avoiding contact with dirt

### 3-FOLD FILTER SYSTEM

An efficient 3-fold filter system (pre-filter, replaceable and washable pleat filter, motor filter) complete with cyclone separator results in clean blast air and efficient vacuuming with high suction force

### INCL. EXTENSIVE ACCESSORIES

Included in delivery: wall holder for space-saving storage, 2-in-1 universal nozzle and flexible crevice nozzle for vacuuming at hard-to-reach areas

### 4x SPOTLIGHT LEDs

There are 4x spotlight LEDs for easy cleaning even in dark and hard-to-reach places such as under a bed or cupboard

### RUBBERISED WHEELS

Floor protecting and quiet working due to rubberised wheels

	TE-SV 18 Li - Solo <b>EXPERT</b>
PXC battery voltage / capacity	18 V / -
Tank volume	0.6 l
Product weight	1.05 kg (excl. battery)
Speed settings	2
Number of batteries / number of chargers	0 / 0
Nozzles	Motorised power brush, 2-in-1 universal nozzle, flexible crevice nozzle
Filters	3-fold filter system: pre-filter, replaceable and washable pleat filter, motor filter
Wall bracket	•
Rubberised wheels	•
LED	•
Packaging	Colour box
Article number	23.471.80

**MORE ACCESSORIES FOR THE TE-SV 18 Li CAN BE FOUND ON PAGE 151**



## CORDLESS HANDHELD VACUUM CLEANER



	<b>TE-VC 18 Li - Solo</b> <b>EXPERT</b>
PXC battery voltage / capacity	18 V / -
Suction power	42 mbar
Tank	Plastic, 0.54 l
Suction hose length	46.5 cm
Product weight	0.9 kg (excl. battery)
Speed settings	1
Number of batteries / number of chargers	0 / 0
Nozzles	Floor, crevice, upholstery nozzle (1x each)
Filters	1 washable synthesis filter (1x each)
Wall bracket	•
Packaging	Colour box
Article number	23.471.20



4 006825 612646

## CORDLESS ASH VACUUM CLEANER



	<b>TE-AV 18/15 Li C - Solo</b> <b>EXPERT</b>
PXC battery voltage / capacity	18 V / -
Suction power	100 mbar
Tank	Stainless steel, 15 l
Suction hose length / diameter	120 cm / 36 mm
Product weight	3.1 kg (excl. battery)
Filter cleaning technology	•
Carry handle	•
Castors	•
Hose rewind	•
Accessory storage	•
Number of batteries / number of chargers	0 / 0
Pleated filter	•
Packaging	Colour box
Article number	23.517.00



4 006825 655407



# CORDLESS PUSH SWEEPER

## DIRT TANK

The extra-large dirt tank lets you sweep without interruption and stands securely when removed

## CORDLESS OPERATION WITH POWER X-CHANGE LITHIUM-ION BATTERY

Cordless operation means that corners and hard-to-reach areas are easy to sweep as well. The rechargeable battery can be used in all the devices from the Power X-Change family

## ON/OFF SWITCH ON THE HANDLE

for comfortable use without straining your back

## STORAGE POSITION

Adjustment facility for comfortable cleaning and space-saving storage

## LONG HANDLE

The height-adjustable and folding long handle provides plenty of advantages for both tall and short users alike, as well as for storage

## WHEELS AND ROLLERS

The two large wheels and the two swivel rollers ensure good handling on different surfaces

## SWEEPING BRUSH

With a sweeping width of 610 mm and area coverage of 1800 m<sup>2</sup>/h, even large areas can quickly be made dirt free too



Cordless Push Sweeper  
**TE-SW 18/610 Li**

## CORDLESS PUSH SWEEPER



	<b>TE-SW 18/610 Li - Solo</b> <b>EXPERT</b>
PXC battery voltage / capacity	18 V / -
Max. area coverage	1800 m <sup>2</sup> /h
Working width	610 mm
Dirt tank	20 l
Number of side brushes	2
Product weight	10.3 kg (excl. battery)
Height-adjustable handlebar	•
Folding handlebar	•
Number of batteries / number of chargers	0 / 0
Article number	23.520.40



# CORDLESS DRAIN CLEANER

## INLET AND OUTLET

Thanks to an inlet and an outlet it is both quick and easy to clean the coil because no water collects in the drum but drips out again straight away

## AUTOMATIC ENTRY AND EXIT

The coil enters the pipe effortlessly and automatically by motorized feed

Cordless Drain Cleaner  
**TE-DA 18/760 Li**

## GALVANIZED COIL

The galvanized coil prevents rust formation and guarantees the tool's durability

## LED

The cleaning area is illuminated during operation so that you can view even the darkest spaces

## LOCKING MECHANISM

Even the most stubborn dirt can be removed from the pipes thanks to the locking mechanism

## FORWARD/REVERSE FACILITY

Using the forward/reverse facility it is easy, for example, to dislodge a blocked coil

## POWER X-CHANGE LITHIUM-ION BATTERY

The rechargeable battery can be used in all the devices from the Power X-Change family

## USER-FRIENDLY

User-friendly operation thanks to a standing base and an ergonomic design with Softgrip



Illustration similar

## CORDLESS DRAIN CLEANER



Illustration similar

	<b>TE-DA 18/760 Li - Solo</b>	<b>NEW</b>
	<b>EXPERT</b>	
PXC battery voltage / capacity	18 V / -	
Speed	0 - 560 min <sup>-1</sup>	
Length of coil	7.6 m	
Coil diameter	7 mm	
Pipe diameter	16 - 55 mm	
Product weight	1.7 kg (excl. battery)	
Clockwise and counter-clockwise operation	•	
Forward/reverse facility	•	
Galvanized coil	•	
LED	•	
Water inlet and outlet	•	
Coil locking mechanism	•	
Number of batteries / number of chargers	0 / 0	
Article number	45.141.60	



4 006825 664409

# 6-IN-1 CORDLESS HYBRID COMPRESSOR

**MULTIFUNCTIONAL**

High-pressure pumping, low-pressure pumping and low-pressure suctioning with just a single device

**COMFORTABLE TRANSPORT**

Low product weight and soft grip for easy transport

**ACCESSORIES**

With the 3-piece inflation adapter set for balls, tyres and air mattresses, the compressor is highly versatile

**HYBRID FUNCTION**

For use with a power cable or rechargeable battery on the go

**MANUAL PRESSURE SETTING ADJUSTMENT**

High-pressure pump with adjustable pressure settings up to 11 bar, auto shutoff function when the pressure is reached

**PRESSURE INDICATOR**

Digital pressure indicator for the pressure of the high-pressure pump

6-in-1 Cordless Hybrid Compressor  
**PRESSITO**

**COMFORTABLE**

Cable and hoses are kept directly on the tool itself

**POWER X-CHANGE LITHIUM-ION BATTERY**

The rechargeable battery can be used in all the devices from the Power X-Change family



## 6-IN-1 CORDLESS HYBRID COMPRESSOR



PRESSITO	
EXPERT	
PXC battery voltage / capacity	18 V / -
Mains connection	220 - 240 ~ 50 Hz
Suction power	21 l/min
Output rate 0 bar   4 bar   7 bar	16 l/min   10 l/min   8 l/min
Max. operating pressure	11 bar
Product weight	2.1 kg (excl. battery)
Hybrid function	•
Digital pressure indicator	•
Soft grip	•
Cable storage	•
Accessory storage	•
Number of batteries / number of chargers	0 / 0
Hoses incl.	High pressure hose, low pressure hose
Adapter set	•
Packaging	Colour box
Article number	40.204.60



### 3-IN-1 CORDLESS COMPRESSOR



	<b>PRESSITO 18/21</b> <b>EXPERT</b> <span style="float: right;"><b>NEW</b></span>
PXC battery voltage / capacity	18 V / -
Suction power	21 l/min
Output rate 0 bar   4 bar   7 bar	14 l/min   9 l/min   6 l/min
Max. operating pressure	10.5 bar
Product weight	2.1 kg (excl. battery)
Push button for high-pressure pump	•
Digital pressure indicator	•
Soft grip	•
Accessory storage	•
Number of batteries / number of chargers	0 / 0
Hoses incl.	High pressure hose, low pressure hose
Adapter set	•
Packaging	Colour box
Article number	40.204.67



### CORDLESS COMPRESSORS

**TWIN-PACK®**  
18V + 18V **36V**  
TECHNOLOGY



	<b>TE-AC 36/6/8 Li OF Set - Solo</b> <b>EXPERT</b>	<b>TE-AC 36/8 Li OF Set - Solo</b> <b>EXPERT</b> <span style="float: right;"><b>NEW</b></span>
PXC battery voltage / capacity	2x 18 V / -	2x 18 V / -
Suction power	130 l/min	130 l/min
Output rate 0 bar   4 bar   7 bar	90 l/min   55 l/min   38 l/min	90 l/min   55 l/min   38 l/min
Tank capacity	6 l	without pressure chamber
Max. operating pressure	8 bar	8 bar
Product weight	9.7 kg (excl. batteries)	5.5 kg (excl. batteries)
Pressure reducer	•	-
Accessory storage	•	•
Number of batteries / number of chargers	0 / 0	0 / 0
Compressed air hose	•	•
Blow-out pistol	•	•
Tire pressure gauge	•	•
Adapter set	•	•
Packaging	Colour box	Colour box
Article number	40.204.50	40.204.40



## CORDLESS CAR COMPRESSOR



	<b>CE-CC 18 Li-Solo</b>	<b>NEW</b>
	<b>CAR EXPERT</b>	
PXC battery voltage / capacity	18 V / -	
Output rate 0 bar   4 bar   7 bar	12 l/min   10 l/min   8 l/min	
Max. operating pressure	11 bar	
Length of pressure hose	60 cm	
Product weight	0.8 kg (excl. battery)	
Digital pressure indicator	•	
Setting of the required pressure	•	
Automatic switch-off	•	
Manual pumping	•	
Accessory storage	•	
Suitable for	Car tyres, cycle tyres and balls	
Number of batteries / number of chargers	0 / 0	
Adapter set	3-piece	
Packaging	Colour box	
Article number	20.710.10	



## CORDLESS AIR PUMP



	<b>CE-AP 18 Li-Solo</b>	<b>NEW</b>
	<b>CAR EXPERT</b>	
PXC battery voltage / capacity	18 V / -	
Max. delivery rate	670 l/min	
Max. operating pressure	0.05 bar	
Product weight	0.4 kg (excl. battery)	
Suitable for deflation	•	
Locking switch	•	
LED	•	
Suitable for	Rubber dinghies, air mattresses, leisure articles	
Number of batteries / number of chargers	0 / 0	
Valve adapter	2x	
Packaging	Colour box	
Article number	20.701.10	



# CORDLESS TILE CUTTING MACHINE

## CUTTING WHEEL GUARD

The cutting wheel guard provides the necessary safety and protects against splashwater

## PARALLEL STOP WITH ANGLE STOP

Parallel stop with angle scale for exact straight cuts

## TILTING TABLE

Tilting table with angle scale (0 – 45°) for mitre cuts

## WATER TANK

Integrated water tank with Min/Max indicator for cutting wheel cooling and dust reduction

## RUBBER FEET

Non-slip and vibration rubber feet for secure hold

## FLEXIBILITY – THANKS TO CORDLESS OPERATION

For flexible use everywhere thanks to a battery-powered motor and low weight

## POWER X-CHANGE LITHIUM-ION BATTERY

The rechargeable battery can be used in all the devices from the Power X-Change family



Cordless Tile Cutting Machine  
**TE-TC 18/115 Li**

## CARRY-HANDLES

Integrated carry aids for easy transport and user-friendly storage

## CORDLESS TILE CUTTING MACHINE



	<b>TE-TC 18/115 Li - Solo</b>	<b>NEW</b>
	<b>EXPERT</b>	
PXC battery voltage / capacity	18 V / -	
Speed	3800 min <sup>-1</sup>	
Cutting height 90°   45°	24 mm   16 mm	
Cutting length	-	
Cutting wheel	Ø 115 x Ø 22.2 mm	
Mitre cut	0° to 45° to the left	
Product weight	3.4 kg (excl. battery)	
Water bath container	•	
Laser	-	
Transport wheels	-	
Parallel stop	•	
Angle stop	•	
Number of batteries / number of chargers	0 / 0	
Article number	43.011.90	



4 006825 657500

## ACCESSORIES – BATTERIES



Illustration similar



	5-8 Ah Multi-Ah Power X-Change Plus Battery <b>NEW</b>	4-6 Ah Multi-Ah Power X-Change Plus Battery
Items supplied	1 battery	1 battery
PXC battery voltage / capacity	18 V / 8.0 Ah or 5.0 Ah (depending on the application)	18 V / 6.0 Ah or 4.0 Ah (depending on the application)
Battery power	max. 1350 W	max. 1350 W
Product weight	1.04 kg	1.02 kg
Article number	45.116.00	45.115.02



4 006825 665055



4 006825 644210

## ACCESSORIES – BATTERIES



	5.2 Ah Power X-Change Plus Battery	4.0 Ah Power X-Change Plus Battery <b>NEW</b>	3.0 Ah Power X-Change Plus Battery
Items supplied	1 battery	1 battery	1 battery
PXC battery voltage / capacity	18 V / 5.2 Ah	18 V / 4.0 Ah	18 V / 3.0 Ah
Battery power	max. 1260 W	max. 900 W	max. 900 W
Product weight	0.89 kg	0.58 kg	0.57 kg
Article number	45.114.37	45.115.53	45.115.01



4 006825 616606



4 006825 660869



4 006825 644197



### 4-6 AH MULTI-AH POWER X-CHANGE PLUS BATTERY

Thanks to MULTI-Ah technology, switching over from a 4 Ah battery to a 6 Ah battery is really easy and can be done with just the push of a button. The 4 Ah battery has a 3x longer total service life and is suitable for lighter applications (e.g. cordless lamp or cordless screwdriver). The 6 Ah battery offers the maximum running time for more capacity-intensive applications (e.g. cordless lawn mower or cordless wet and dry vacuum cleaners).

4 Ah



**300%**  
+ more lifetime<sup>1)</sup>

6 Ah



**50%**  
+ more runtime<sup>2)</sup>

<sup>1)</sup> in comparison to every standard lithium-ion battery  
<sup>2)</sup> in comparison to the 4.0 Ah battery

## ACCESSORIES – BATTERIES



	4.0 Ah Power X-Change Battery	2.5 Ah Power X-Change Battery <b>NEW</b>	2.0 Ah Power X-Change Battery
Items supplied	1 battery	1 battery	1 battery
PXC battery voltage / capacity	18 V / 4.0 Ah	18 V / 2.5 Ah	18 V / 2.0 Ah
Battery power	max. 900 W	max. 720 W	max. 450 W
Product weight	0.65 kg	0.46 kg	0.40 kg
Article number	45.113.96	45.115.16	45.113.95



## ACCESSORIES – BATTERIES



	2x 5.2 Ah Power X-Change Twin-Pack <b>NEW</b>	2x 4.0 Ah Power X-Change Twin-Pack	2x 2.5 Ah Power X-Change Twin-Pack
Items supplied	2 batteries	2 batteries	2 batteries
PXC battery voltage / capacity	2x 18 V / 5.2 Ah	2x 18 V / 4.0 Ah	2x 18 V / 2.5 Ah
Battery power	max. 2x 1260 W	max. 2x 900 W	max. 2x 720 W
Product weight	1.78 kg	1.32 kg	0.92 kg
Article number	45.115.26	45.114.89	45.115.24



## ACCESSORIES



	Battery Mounting Gadget <b>NEW</b>
Items supplied	2 battery mounting gadgets, 4 screws, 4 dowels
Can be used for	all 18 V Power X-Change batteries
Article number	45.141.55





## ACCESSORIES – CHARGERS



	2x2 Power X-Quattrocharger 4 A <span style="float: right;">NEW</span>	Power X-Boost Charger 6 A
Items supplied	1 charger	1 charger
Can be used for	18 V Power X-Change batteries	18 V Power X-Change batteries
Charging current	4 A	3 - 6 A
Multiple-port charger	• 4 charging slots allow 2 batteries to be charged at the same time	-
Boost mode	-	•
Integrated wall mount	-	•
Mains voltage	220 - 240 V ~ 50-60 Hz	220 - 240 V ~ 50-60 Hz
Article number	45.121.02	45.120.64



## ACCESSORIES – CHARGERS



	Power X-Twincharger 3 A	Power X-Fastcharger 4 A
Items supplied	1 charger	1 charger
Can be used for	18 V Power X-Change batteries	18 V Power X-Change batteries
Charging current	3 A	4 A
Multiple-port charger	• 2 charging slots allow 2 batteries to be charged at the same time	-
Boost mode	-	-
Integrated wall mount	•	•
Mains voltage	220 - 240 V ~ 50-60 Hz	220 - 240 V ~ 50-60 Hz
Article number	45.120.69	45.121.03



**OUT-AND-ABOUT AND NO POWER SOCKET AVAILABLE?  
NO PROBLEM  
THANKS TO EINHELL!**



	Power X-Car Charger 3 A <span style="float: right;">NEW</span>
Items supplied	1 charger
Can be used for	18 V Power X-Change batteries
Charging current	3 A
Multiple-port charger	-
Boost mode	-
Integrated wall mount	•
Operating voltage	12 V DC
Article number	45.121.13



## ACCESSORIES – STARTER KITS



	2x 3.0 Ah PXC Twincharger Starter Kit	2x 4.0 Ah PXC Twincharger Starter Kit <span style="float: right;">NEW</span>
Items supplied	2 batteries + 1 Twin Charger	2 batteries + 1 Twin Charger
PXC battery voltage / capacity	2x 18 V / 2x 3.0 Ah	2x 18 V / 2x 4.0 Ah
Battery power	max. 2x 900 W	max. 2x 900 W
Charging current	3 A	3 A
Mains voltage	220 - 240 V ~ 50-60 Hz	220 - 240 V ~ 50-60 Hz
Multiple-port charger	• 2 charging slots allow 2 batteries to be charged at the same time	• 2 charging slots allow 2 batteries to be charged at the same time
Boost mode	-	-
Integrated wall mount	•	•
Article number	45.120.83	45.121.12



## ACCESSORIES – STARTER KITS

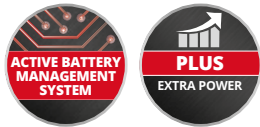

	5.2 Ah PXC Fastcharger Starter-Kit	4.0 Ah Power X-Change Starter-Kit	2.5 Ah Power X-Change Starter-Kit
Items supplied	1 battery + 1 Power X-Fastcharger 4 A	1 battery + 1 Power X-Charger 3 A	1 battery + 1 Power X-Charger 3 A
PXC battery voltage / capacity	18 V / 5.2 Ah	18 V / 4.0 Ah	18 V / 2.5 Ah
Battery power	max. 1260 W	max. 900 W	max. 720 W
Charging current	4 A	3 A	3 A
Mains voltage	220 - 240 V ~ 50-60 Hz	220 - 240 V ~ 50-60 Hz	220 - 240 V ~ 50-60 Hz
Multiple-port charger	-	-	-
Boost mode	-	-	-
Integrated wall mount	•	•	•
Article number	45.121.14	45.120.42	45.120.97



## CHARGING TIMES



	1.5 Ah	2.0 Ah	2.5 Ah	3.0 Ah	4.0 Ah	5.2 Ah	6.0 Ah	8.0 Ah	
Power X-Charger 3 A									<div style="text-align: right;"> <p><b>Shorter charging time</b></p> <p><b>-25%</b></p> <p><b>-50%</b></p> </div>
Power X-Twincharger 3 A (parallel charging of 2 batteries)	30 min	40 min	50 min	60 min	75 min	100 min	120 min	150 min	
Power X-Car Charger 3 A									
Power X-Fastcharger 4 A									
2x2 Power X-Quattrocharger 4 A (parallel charging of 2 batteries)	24 min	30 min	37 min	45 min	60 min	80 min	90 min	120 min	
Power X-Boostcharger 6 A	24 min	30 min	27 min	32 min	40 min	50 min	60 min	80 min	

**THE BATTERY GUIDE – IT'S WHAT YOU NEED THAT MATTERS.**



			18 V 2.0 Ah	18 V 2.5 Ah	18 V 3.0 Ah	18 V 4.0 Ah	18 V 5.2 Ah	18 V 6.0 Ah	18 V 8.0 Ah
Cordless Drills	TE-CD 18/60 Li Brushless		350 pcs	440 pcs	530 pcs	700 pcs	920 pcs	1060 pcs	1400 pcs
	TE-CD 18/50 Li Brushless		320 pcs	400 pcs	480 pcs	640 pcs	830 pcs	960 pcs	1280 pcs
	TE-CD 18/40 Li Brushless		300 pcs	380 pcs	450 pcs	600 pcs	780 pcs	900 pcs	1200 pcs
	TE-CD 18 Li E		300 pcs	380 pcs	450 pcs	600 pcs	790 pcs	900 pcs	1200 pcs
	TE-CD 18/45 3X-Li		320 pcs	400 pcs	480 pcs	640 pcs	830 pcs	960 pcs	1280 pcs
	TE-CD 18/40 Li		305 pcs	380 pcs	460 pcs	610 pcs	770 pcs	920 pcs	1220 pcs
	TE-CD 18/2 Li		240 pcs	300 pcs	360 pcs	480 pcs	625 pcs	720 pcs	960 pcs
	TC-CD 18/35 Li		295 pcs	366 pcs	440 pcs	590 pcs	760 pcs	880 pcs	1180 pcs
Cordless Impact Drills	TE-CD 18/60 Li-i Brushless		350 pcs	440 pcs	530 pcs	700 pcs	920 pcs	1060 pcs	1400 pcs
	TE-CD 18/50 Li-i Brushless		320 pcs	400 pcs	480 pcs	640 pcs	830 pcs	960 pcs	1280 pcs
	TE-CD 18/48 Li-i		310 pcs	380 pcs	460 pcs	620 pcs	780 pcs	910 pcs	1240 pcs
	TE-CD 18/40 Li-i		305 pcs	380 pcs	460 pcs	610 pcs	770 pcs	920 pcs	1220 pcs
	TE-CD 18/2 Li-i		240 pcs	300 pcs	360 pcs	480 pcs	625 pcs	720 pcs	960 pcs
Cordless Drywall Screwdriver	TE-DY 18 Li		1100 pcs	1350 pcs	1600 pcs	2200 pcs	2800 pcs	3300 pcs	4400 pcs
Cordless Impact Drivers / Wrenches	TE-CI 18 Li Brushless		280 pcs	350 pcs	420 pcs	560 pcs	730 pcs	840 pcs	1120 pcs
	TE-CI 18/1 Li		185 pcs	230 pcs	280 pcs	370 pcs	520 pcs	560 pcs	740 pcs
	IMPAXXO 18/400		55 pcs	68 pcs	80 pcs	110 pcs	140 pcs	160 pcs	220 pcs
	IMPAXXO 18/230		95 pcs	115 pcs	140 pcs	190 pcs	250 pcs	280 pcs	380 pcs
Cordless Impact Drill	TC-ID 18 Li		60 pcs	75 pcs	90 pcs	120 pcs	156 pcs	180 pcs	240 pcs
Cordless Paint/Mortar Mixer	TE-MX 18 Li		20 min 16 min	25 min 20 min	30 min 24 min	40 min 32 min	52 min 42 min	60 min 48 min	80 min 64 min
Cordless Rotary Hammers	HEROCCO 36/28		79 holes	105 holes	126 holes	169 holes	222 holes	276 holes	338 holes
	HEROCCO		335 pcs 87 holes	417 pcs 108 holes	500 pcs 130 holes	670 pcs 174 holes	870 pcs 225 holes	1000 pcs 260 holes	1340 pcs 348 holes
	TE-HD 18 Li		180 pcs 45 holes	225 pcs 56 holes	270 pcs 68 holes	360 pcs 90 holes	465 pcs 117 holes	540 pcs 135 holes	720 pcs 180 holes
	TE-HD 18/12 Li		185 pcs 45 holes	226 pcs 57 holes	270 pcs 82 holes	360 pcs 96 holes	474 pcs 140 holes	540 pcs 166 holes	720 pcs 182 holes

## THE BATTERY GUIDE – IT'S WHAT YOU NEED THAT MATTERS.

			18 V 2.0 Ah	18 V 2.5 Ah	18 V 3.0 Ah	18 V 4.0 Ah	18 V 5.2 Ah	18 V 6.0 Ah	18 V 8.0 Ah
Cordless Angle Grinders	AXXIO 36/230 Q		32 pcs	41 pcs	48 pcs	62 pcs	81 pcs	93 pcs	124 pcs
	AXXIO 18/150 Li		33 pcs	37 pcs	46 pcs	61 pcs	85 pcs	92 pcs	122 pcs
	AXXIO		33 pcs	37 pcs	46 pcs	61 pcs	85 pcs	92 pcs	122 pcs
	AXXIO 18/125 Q		29 pcs	37 pcs	52 pcs	63 pcs	92 pcs	121 pcs	126 pcs
	AXXIO 18/115 Q		29 pcs	37 pcs	52 pcs	63 pcs	92 pcs	121 pcs	126 pcs
	TE-AG 18/115 Li		20 pcs	25 pcs	30 pcs	40 pcs	60 pcs	70 pcs	80 pcs
	TC-AG 18/115 Li		20 pcs	25 pcs	30 pcs	40 pcs	60 pcs	70 pcs	80 pcs
Cordless Biscuit Jointer	TE-BJ 18 Li		283 pcs	353 pcs	424 pcs	566 pcs	735 pcs	840 pcs	1132 pcs
Cordless Planer	TE-PL 18/82 Li		25 m	28 m	37 m	48 m	58 m	78 m	96 m
Cordless Jigsaws	TE-JS 18 Li		9.5 m	11 m	14 m	20 m	30 m	32 m	40 m
	TC-JS 18 Li		9.5 m	11 m	14 m	20 m	30 m	32 m	40 m
Cordless Circular Saws	TE-CS 18/190 Li Brushless		24 m	30 m	37 m	49 m	63 m	73 m	98 m
	TE-CS 18/165-1 Li		33 m	40 m	49 m	64 m	82 m	98 m	128 m
	TE-CS 18/150 Li		30 m	38 m	45 m	60 m	78 m	90 m	120 m
Cordless Mini Circular Saw	TE-CS 18/89 Li		36 m	50 m	57 m	72 m	104 m	120 m	144 m
Cordless All Purpose Saws	TE-AP 18/28 Li Brushless		226 pcs	332 pcs	417 pcs	556 pcs	723 pcs	834 pcs	1112 pcs
	TE-AP 18/26 Li		207 pcs	259 pcs	320 pcs	414 pcs	572 pcs	640 pcs	828 pcs
	TE-AP 18 Li		185 pcs	240 pcs	290 pcs	370 pcs	570 pcs	580 pcs	740 pcs
Cordless Sliding Mitre Saw	TE-SM 36/210 Li		185 pcs 350 pcs	230 pcs 435 pcs	275 pcs 525 pcs	370 pcs 700 pcs	480 pcs 910 pcs	555 pcs 1050 pcs	740 pcs 1400 pcs
Cordless Mitre Saw	TE-MS 18/210 Li		103 pcs	120 pcs	154 pcs	190 pcs	250 pcs	304 pcs	380 pcs
Cordless Table Saw	TE-TS 36/210 Li		60 m	71 m	92 m	122 m	160 m	184 m	244 m
Cordless Metal Band Saws	TE-MB 18/127 U Li		30 pcs	35 pcs	45 pcs	60 pcs	78 pcs	90 pcs	120 pcs
	TE-MB 18/127 Li		30 pcs	35 pcs	45 pcs	60 pcs	78 pcs	90 pcs	120 pcs
Cordless Multifunctional Tools	VARRITO		30 min 720 pcs	38 min 900 pcs	45 min 1080 pcs	60 min 1440 pcs	78 min 1880 pcs	90 min 2160 pcs	120 min 2880 pcs
	TC-MG 18 Li		30 min 720 pcs	38 min 900 pcs	45 min 1080 pcs	60 min 1440 pcs	78 min 1880 pcs	90 min 2160 pcs	120 min 2880 pcs
Cordless Drywall Polisher	TP-DW 18/225 Li		26 min	33 min	44 min	55 min	68 min	78 min	110 min



			18 V 2.0 Ah	18 V 2.5 Ah	18 V 3.0 Ah	18 V 4.0 Ah	18 V 5.2 Ah	18 V 6.0 Ah	18 V 8.0 Ah	
Cordless Orbital Sanders	TE-OS 18/230 Li		27 min	33 min	40 min	54 min	70 min	80 min	108 min	
	TC-OS 18/187 Li		34 min	42 min	50 min	67 min	87 min	100 min	134 min	
Cordless Multi Sander	TE-OS 18/150 Li		27 min	34 min	40 min	55 min	70 min	80 min	110 min	
Cordless Rotary Sander	TE-RS 18 Li		20 min	25 min	30 min	40 min	52 min	60 min	80 min	
Cordless Polishing/ Sanding Machine	CE-CP 18/180 Li E		20 min	25 min	35 min	43 min	54 min	65 min	86 min	
Cordless Car Polishing Machine	CE-CB 18/254 Li		81 min	93 min	112 min	127 min	200 min	222 min	254 min	
Cordless Nailer	TE-CN 18 Li		2030 pcs 1995 pcs	2670 pcs 2642 pcs	3204 pcs 3171 pcs	4272 pcs 4228 pcs	5554 pcs 5496 pcs	6408 pcs 6342 pcs	8544 min 8456 pcs	
Cordless Paint Spray System	TC-SY 18/60 Li		30 m <sup>2</sup>	38 m <sup>2</sup>	45 m <sup>2</sup>	60 m <sup>2</sup>	78 m <sup>2</sup>	90 m <sup>2</sup>	120 m <sup>2</sup>	
Cordless Speaker	TC-SR 18 Li BT		57 h	72 h	86 h	114 h	148 h	171 h	228 h	
Cordless Radio	TC-RA 18 Li BT		16 h	20.5 h	24.5 h	32.5 h	42.5 h	49 h	65 h	
Cordless Lights	TE-CL 18/2500 LiAC		85 min	107 min	137 min	183 min	238 min	274 min	366 min	
	TE-CL 18/2000 LiAC		115 min	145 min	174 min	230 min	300 min	345 min	460 min	
	TC-CL 18/1800 Li		118 min	140 min	191 min	243 min	300 min	350 min	486 min	
	TC-CL 18 Li H		10 h	12 h	16 h	22 h	32 h	33 h	44 h	
USB Battery Adapter	TC-CP 18 Li USB		12 h	13.5 h	16 h	24 h	32 h	36 h	48 h	
Cordless Blower	TE-CB 18/180 Li		39 min	48 min	62 min	68 min	100 min	124 min	136 min	
Cordless Hot Glue Gun	TE-CG 18 Li		18 pcs	22 pcs	28 pcs	36 pcs	44 pcs	50 pcs	72 pcs	
Cordless Hot Air Gun	TE-HA 18 Li		9 min	11 min	13 min	17 min	22 min	26 min	34 min	
Cordless Wet and Dry Vacuum Cleaners	TP-VC 36/30 S Auto		8 min 11 min	10 min 13 min	12 min 16 min	16 min 22 min	21 min 28 min	24 min 33 min	32 min 44 min	
	TE-VC 36/30 Li S		BOOST ECO	8 min 11 min	10 min 13 min	12 min 16 min	16 min 22 min	21 min 28 min	24 min 33 min	32 min 44 min
	TE-VC 36/25 Li S		8 min 11 min	10 min 13 min	12 min 16 min	16 min 22 min	21 min 28 min	24 min 33 min	32 min 44 min	
	TC-VC 18/20 Li S		10 min	11 min	16 min	20 min	25 min	32 min	40 min	
	TC-VC 18/15 Li		10 min	11 min	16 min	20 min	25 min	32 min	40 min	
	TE-VC 18/10 Li		10 min	12 min	17 min	21 min	26 min	30 min	42 min	

**THE BATTERY GUIDE – IT'S WHAT YOU NEED THAT MATTERS.**

									
			18 V 2.0 Ah	18 V 2.5 Ah	18 V 3.0 Ah	18 V 4.0 Ah	18 V 5.2 Ah	18 V 6.0 Ah	18 V 8.0 Ah
Cordless Stick Vac Cleaner	TE-SV 18 Li	 BOOST ECO	11 min 25 min	13 min 31 min	18 min 38 min	22 min 50 min	28 min 65 min	35 min 80 min	44 min 100 min
Cordless Handheld Vacuum Cleaner	TE-VC 18 Li		16 min	18 min	23 min	31 min	40 min	46 min	62 min
Cordless Ash Vacuum Cleaner	TE-AV 18/15 Li C		15 min	18 min	22 min	30 min	37 min	44 min	60 min
Cordless Push Sweeper	TE-SW 18/610 Li	 	850 m <sup>2</sup> 27 min	1050 m <sup>2</sup> 34 min	1300 m <sup>2</sup> 41 min	1700 m <sup>2</sup> 55 min	2200 m <sup>2</sup> 72 min	2550 m <sup>2</sup> 83 min	3400 m <sup>2</sup> 110 min
Cordless Drain Cleaner	TE-DA 18/760 Li		56 min	68 min	94 min	112 min	143 min	188 min	232 min
6-in-1 Cordless Hybrid Compressor	PRESSITO		30 min	37 min	45 min	60 min	85 min	90 min	120 min
3-in-1 Cordless Compressor	PRESSITO 18/21		30 min	37 min	45 min	60 min	85 min	90 min	120 min
Cordless Compressors	TE-AC 36/6/8 Li OF	 	25 min 400 pcs	29 min 435 pcs	40 min 660 pcs	50 min 800 pcs	60 min 900 pcs	80 min 1320 pcs	100 min 1600 pcs
	TE-AC 36/8 Li OF	 	8 min 6 min	10 min 7.5 min	12 min 9 min	16 min 12 min	21 min 15 min	24 min 18 min	32 min 24 min
Cordless Car Compressor	CE-CC 18 Li		42 min	53 min	63 min	84 min	109 min	126 min	168 min
Cordless Air Pump	CE-AP 18 Li		65 min	81 min	98 min	130 min	169 min	195 min	260 min
Cordless Tile Cutting Machine	TE-TC 18/115 Li		50 pcs	63 pcs	75 pcs	100 pcs	130 pcs	150 pcs	200 pcs

79 holes

**BASIC PERFORMANCE – Upgrade recommended**

Figures shown in lighter fields (for example see above) indicate that we recommend using a battery with greater power/capacity for full power and the appropriate operating time of the machine.

All stated values are maximum values. They were determined under standardised test conditions and may differ from the values achievable in everyday operation.

### Key to Symbols:

	Screwing 6 x 60 mm screws into softwood – max. quantity per battery charge		Max. operating time per battery charge in idle mode
	Tightening/loosening wheel bolts (hexagon head, size 22 mm) – max. quantity per battery charge		Cutting through round plastics Ø 10 mm – max. number of cuts per battery charge
	Screwing drywall screws size 3.9 x 25 mm in dry construction boards		Glue sticks Ø 11 mm, length 200 mm – max. number per battery charge
	Ø 6 mm / 50 mm into brick – max. quantity per battery charge		32 mm nails in softwood at maximum depth setting – max. number per battery charge
	Ø 6 mm / 50 mm into concrete – max. quantity per battery charge		22 mm staples in softwood at maximum depth setting – max. number per battery charge
	Mixing wall paint / mortar, time per battery charge		Max. area coverage per battery charge with paint viscosity of 60 DIN-sec and single application
	Cutting through round steel Ø 12 mm – max. quantity per battery charge		Charging time per battery charge
	Cutting grooves in softwood for flat dowels (size 10) – max. quantity per battery charge		Max. light duration per battery charge
	Planing of softwood (depth: 1 mm, width 50 mm) – max. planing performance (in m) per battery charge		Max. idling time per battery charge in BOOST / ECO mode
	Particleboard 19 mm – max. cutting capacity (in m) per battery charge		Max. area coverage per battery charge at 3 km/h walking speed
	Roundwood Ø 35 mm – max. number of cuts per battery charge		13 mm staples in softwood - max. number per battery charge
	Square softwood 60 x 60 mm – max. number of cuts per battery charge		Max. running time when using a blow-out pistol
	Rectangular tube 40 x 40 x 2 mm – max. number of cuts per battery charge		Max. running time when inflating a car tire to 2.5 bar
	Laminate 195 x 8 mm – max. number of cuts per battery charge		Ceramic tile 15 x 15 cm – max. cutting performance per battery charge

## EVEN MORE FREEDOM WITH POWER X-CHANGE. E-KICKSCOOTER ELMOTO KICK FROM GOVECS.

Einhell opens up its Power X-Change rechargeable battery platform! Together with E-Scooter manufacturer GOVECS, Einhell is helping to get ELMOTO KICK on the road, a road-legal E-Kickscooter with Power X-Change batteries.

With the new E-Kickscooter ELMOTO KICK from GOVECS, emissions-free scooting means you can leave your car at home or park slightly further away and simply jump on the scooter for the last mile.

### ELMOTO KICK

**GOVECS**

- Approval for road use
- 36 V
- V max.: 20 km/h
- Max. range: up to 20 km
- 2 hydraulic disc brakes
- Pneumatic tyres (10")
- Folding handlebar

Article only available without batteries / chargers

Art. No. 48.500.61

The ELMOTO KICK is available in three colors:

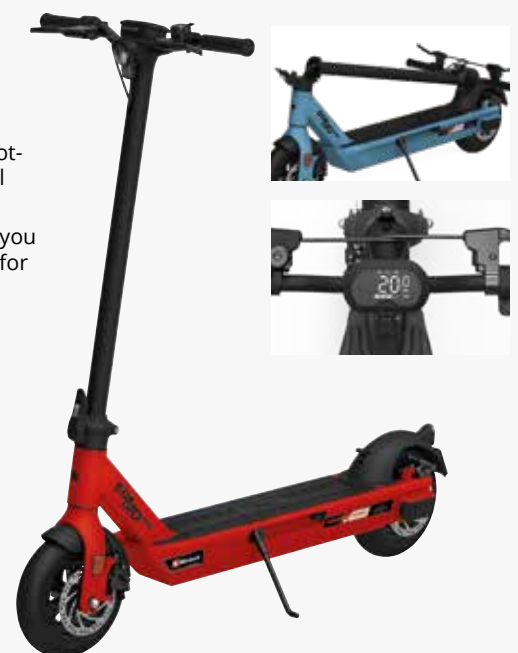

# HANDHELD POWER TOOLS





## CORDLESS SCREWDRIVERS 3.6 V

**3.6 V  
POWER**



	<b>TE-SD 3.6/1 Li</b> <b>EXPERT</b>	<b>TE-SD 3.6 Li Kit</b> <b>EXPERT</b>	<b>TC-SD 3.6 Li</b> <b>CLASSIC</b>
Li-Ion Battery Pack voltage / capacity	3.6 V / 1.5 Ah	3.6 V / 1.5 Ah	3.6 V / 1.3 Ah
Charging time	3 - 5 h	3 h	3 - 5 h
Idle speed	180 min <sup>-1</sup>	200 min <sup>-1</sup>	200 min <sup>-1</sup>
Torque (hard)	4.5 Nm	3.5 Nm	3 Nm
Product weight	0.4 kg	0.4 kg	0.4 kg
Bit locking sleeve	-	•	-
Rotatable	-	•	•
LED	•	•	•
Micro USB charger	•	-	-
Clockwise and counter-clockwise operation	•	•	•
Charge status indicator	-	•	•
Magnetic screw holder	-	•	-
Accessories	10 bits	32-piece bit box	6 bits
Charging station	-	-	-
Packaging	Metal box	Metal box	Colour box
Article number	45.135.01	45.134.95	45.134.42



4 006825 622744



4 006825 598575



4 006825 604733

## CORDLESS DRILLS 12 V

**REMOVABLE  
DRILL  
CHUCK**



	<b>TE-CD 12/1 X-Li (1x 2.0 Ah)</b> <b>EXPERT</b>	<b>TE-CD 12/1 3X-Li (1x 2.0 Ah)</b> <b>EXPERT</b>
Li-Ion Battery Pack voltage / capacity	12 V / 2.0 Ah	12 V / 2.0 Ah
Charging time	45 min	45 min
Idle speed	0 - 400 / 0 - 1400 min <sup>-1</sup>	0 - 400 / 0 - 1400 min <sup>-1</sup>
Torque (hard)	30 Nm	30 Nm
Torque settings	19+1	19+1
Drill chuck	10 mm	10 mm
Product weight	1.1 kg (incl. battery)	1.1 kg (incl. battery)
Number of removable attachments	1	3
Metal gear box	•	•
Quick stop	•	•
LED	•	•
Removable drill chuck	•	•
Number of batteries / number of chargers	1 / 1x 45 min charger	1 / 1x 45 min charger
Accessories	-	-
Packaging	Colour box	Colour box
Article number	45.135.92	45.135.95



4 006825 628685



4 006825 651690

## CORDLESS DRILLS 12 V

**30 Nm**  
**HIGH POWER**



	<b>TE-CD 12/1 Li (1x 2.0 Ah)</b> <b>EXPERT</b>	<b>TE-CD 12/1 Li (2x 2.0 Ah)</b> <b>EXPERT</b>
Li-Ion Battery Pack voltage / capacity	12 V / 2.0 Ah	12 V / 2.0 Ah
Charging time	45 min	45 min
Idle speed	0 - 400 / 0 - 1400 min <sup>-1</sup>	0 - 400 / 0 - 1400 min <sup>-1</sup>
Torque (hard)	30 Nm	30 Nm
Torque settings	19+1	19+1
Drill chuck	10 mm	10 mm
Product weight	1.1 kg (incl. battery)	1.1 kg (incl. battery)
Number of removable attachments	-	-
Metal gear box	•	•
Quick stop	•	•
LED	•	•
Removable drill chuck	-	-
Number of batteries / number of chargers	1 / 1x 45 min charger	2 / 1x 45 min charger
Accessories	5 bits	5 bits
Packaging	Colour box	Colour box
Article number	45.135.90	45.135.94



## CORDLESS DRILLS 12 V

**DRILL+**  
**SCREW**



	<b>TE-CD 12/1 Li +22 +CL (2x 2.0 Ah)</b> <b>EXPERT</b> <b>NEW</b>	<b>TH-CD 12-2 Li</b> <b>CLASSIC</b>
Li-Ion Battery Pack voltage / capacity	12 V / 2.0 Ah	12 V / 1.3 Ah
Charging time	45 min	3 - 5 h
Idle speed	0 - 400 / 0 - 1400 min <sup>-1</sup>	0 - 350 / 0 - 1300 min <sup>-1</sup>
Torque (hard)	30 Nm	24 Nm
Torque settings	19+1	19+1
Drill chuck	10 mm	10 mm
Product weight	1.1 kg (incl. battery)	1.0 kg (incl. battery)
Number of removable attachments	-	-
Metal gear box	•	•
Quick stop	•	•
LED	•	-
Removable drill chuck	-	-
Number of batteries / number of chargers	2 / 1x 45 min charger	1 / 1x 3-5 h charger
Accessories	22-piece in bit box, cordless light: 12 V, 100 lm, light ON time 20 h, 180° turnable head	-
Packaging	Colour box	Colour box
Article number	45.135.98	45.136.60



## CORDLESS IMPACT DRILL 12 V



	TE-CD 12/1 Li-i (2x 2.0 Ah) <b>EXPERT</b>
Li-Ion Battery Pack voltage / capacity	12 V / 2.0 Ah
Charging time	45 min
Idle speed	0 - 400 / 0 - 1400 min <sup>-1</sup>
Blow rate	0 - 6000 / 0 - 21000 min <sup>-1</sup>
Torque (hard)	30 Nm
Torque settings	20+1+1
Drill chuck	10 mm
Product weight	1.2 kg (incl. battery)
Metal gear box	•
Quick stop	•
LED	•
Removable drill chuck	-
Clockwise and counter-clockwise operation	•
Number of batteries / number of chargers	2 / 1x 45 min charger
Additional handle	-
Packaging	Colour box
Article number	45.138.90



4 006825 628692

## CORDLESS IMPACT DRIVER 12 V



	TE-CI 12 Li (1x 2.0 Ah) <b>EXPERT</b>
Li-Ion Battery Pack voltage / capacity	12 V / 2.0 Ah
Charging time	45 min
Idle speed	0 - 2400 min <sup>-1</sup>
Torque (hard)	90 Nm
Bit mount	Internal hexagon 6.35 mm (1/4")
Product weight	1.1 kg (incl. battery)
Brushless motor	-
LED	•
Metal gear box	•
Electronic speed control	•
Number of batteries / number of chargers	1 / 1x 45 min charger
Accessories	-
Packaging	Colour box
Article number	45.100.50



4 006825 628708

## DRYWALL SCREWDRIVER

**AUTO-  
START-  
STOP**



	<b>TH-DY 500 E</b> <b>CLASSIC</b>
Mains connection	230 V ~ 50 Hz
Rated input	500 W
Speed	0 - 2200 min <sup>-1</sup>
Tool mounting	Internal hexagon 6.35 mm (1/4")
Product weight	1.7 kg
Aluminium gear head	•
Adjustable screwing depth	•
Automatic start/stop gearing	•
Belt clip	•
Locking button for permanent operation	•
Electronic speed control	•
Packaging	Colour box
Article number	42.599.05



4 006825 587821

## IMPACT DRILLS

**2 FUNCTIONS**



	<b>TC-ID 1000 E</b> <b>CLASSIC</b>	<b>TC-ID 1000 E Kit</b> <b>CLASSIC</b>	<b>TE-ID 650 E</b> <b>EXPERT</b>
Mains connection	230 V ~ 50 Hz	230 - 240 V ~ 50 Hz	220 - 240 V ~ 50 Hz
Rated input	1010 W	1010 W	650 W
Idle speed	0 - 3000 min <sup>-1</sup>	0 - 3000 min <sup>-1</sup>	0 - 3000 min <sup>-1</sup>
Blow rate	0 - 48000 min <sup>-1</sup>	0 - 48000 min <sup>-1</sup>	0 - 48000 min <sup>-1</sup>
Drilling capacity, wood	32 mm	32 mm	25 mm
Drilling capacity, cement	16 mm	16 mm	13 mm
Drilling capacity, steel	13 mm	13 mm	10 mm
Drill chuck	13 mm	13 mm	13 mm
Product weight	2.1 kg	2.0 kg	2.1 kg
Speed control electronics	•	•	•
Spindle Lock	-	-	•
Soft grip	•	•	•
Metal drill chuck	•	-	•
Additional handle	•	•	•
Accessories	-	16-piece drill bits set	-
Packaging	Colour box	Bag	Colour box
Article number	42.598.25	42.598.44	42.597.35



4 006825 587777



4 006825 635003



4 006825 565690

## IMPACT DRILLS



	TC-ID 720/1 E <b>CLASSIC</b>	TC-ID 720/1 E Kit <b>CLASSIC</b>
Mains connection	220 - 240 V ~ 50-60 Hz	220 - 240 V ~ 50-60 Hz
Rated input	720 W	720 W
Idle speed	0 - 2800 min <sup>-1</sup>	0 - 2800 min <sup>-1</sup>
Blow rate	0 - 44800 min <sup>-1</sup>	0 - 44800 min <sup>-1</sup>
Drilling capacity, wood	30 mm	30 mm
Drilling capacity, cement	13 mm	13 mm
Drilling capacity, steel	10 mm	10 mm
Drill chuck	13 mm	13 mm
Product weight	2.0 kg	2.0 kg
Speed control electronics	•	•
Spindle Lock	-	-
Soft grip	•	•
Metal drill chuck	-	-
Additional handle	•	•
Accessories	-	5-piece drill bits set
Packaging	Colour box	E-Box Basic
Article number	42.598.48	42.598.46



## IMPACT DRILLS



	TC-ID 650 E <b>CLASSIC</b>	TE-ID 500 E <b>EXPERT</b>	TC-ID 550 E <b>CLASSIC</b>
Mains connection	230 V ~ 50 Hz	220 - 240 V ~ 50/60 Hz	220 - 240 V ~ 50/60 Hz
Rated input	650 W	550 W	550 W
Idle speed	0 - 2600 min <sup>-1</sup>	0 - 3000 min <sup>-1</sup>	0 - 2800 min <sup>-1</sup>
Blow rate	0 - 41600 min <sup>-1</sup>	0 - 48000 min <sup>-1</sup>	0 - 44800 min <sup>-1</sup>
Drilling capacity, wood	25 mm	25 mm	25 mm
Drilling capacity, cement	13 mm	10 mm	13 mm
Drilling capacity, steel	10 mm	8 mm	10 mm
Drill chuck	13 mm	13 mm	13 mm
Product weight	1.8 kg	1.7 kg	1.7 kg
Speed control electronics	•	•	•
Spindle Lock	-	-	-
Soft grip	-	•	•
Metal drill chuck	-	-	-
Additional handle	•	•	•
Accessories	-	5-piece drill bits set	-
Packaging	Colour box	Colour box	Colour box
Article number	42.586.82	42.596.10	42.586.21



## ROTARY HAMMERS 2 KG CLASS



	<b>TE-RH 950 5F</b> <b>EXPERT</b> <span style="float: right;"><b>NEW</b></span>
Mains connection	220 - 240 V ~ 50 Hz
Rated input	950 W
Idle speed	0 - 1200 / 0 - 2600 min <sup>-1</sup>
Blow rate	0 - 4500 min <sup>-1</sup>
Impact force	3.0 J
Drilling capacity, cement	28 mm
Drill chuck	SDS-plus
Product weight	3.8 kg
Speed control electronics	•
Vibration-cushioned main handle	-
Overload safety stop	•
Pneumatic impact mechanism	•
Functions	5
Lock for continuous operation	•
Additional handle	•
Metal depth stop	•
Accessories	Quick-action chuck
Packaging	E-Box Basic
Article number	42.579.78



## ROTARY HAMMERS 2 KG CLASS



	<b>TC-RH 800 4F</b> <b>CLASSIC</b>	<b>TC-RH 620 4F</b> <b>CLASSIC</b>	<b>TC-RH 620 4F Kit</b> <b>CLASSIC</b> <span style="float: right;"><b>NEW</b></span>
Mains connection	220 - 240 V ~ 50 Hz	230 - 240 V ~ 50 Hz	230 - 240 V ~ 50 Hz
Rated input	800 W	620 W	620 W
Idle speed	0 - 930 min <sup>-1</sup>	0 - 1250 min <sup>-1</sup>	0 - 1250 min <sup>-1</sup>
Blow rate	0 - 4500 min <sup>-1</sup>	0 - 5200 min <sup>-1</sup>	0 - 5200 min <sup>-1</sup>
Impact force	2.6 J	2.2 J	2.2 J
Drilling capacity, cement	26 mm	20 mm	20 mm
Drill chuck	SDS-plus	SDS-plus	SDS-plus
Product weight	3.2 kg	2.8 kg	2.8 kg
Speed control electronics	•	•	•
Vibration-cushioned main handle	-	-	-
Overload safety stop	•	•	•
Pneumatic impact mechanism	•	•	•
Functions	4	4	4
Lock for continuous operation	•	•	•
Additional handle	•	•	•
Metal depth stop	•	•	•
Accessories	-	-	10 SDS-plus drill bits / 1 SDS-plus chisel
Packaging	E-Box Basic	E-Box Basic	E-Box Basic
Article number	42.579.80	42.579.90	42.579.92



## ROTARY HAMMERS 5 KG CLASS

ANTI  
VIBRATION  
SYSTEM



	TE-RH 40 3F <b>EXPERT</b>	TE-RH 38 3F <b>EXPERT</b>	TE-RH 32 4F Kit <b>EXPERT</b>
Mains connection	220 - 240 V ~ 50 Hz	220 - 240 V ~ 50 Hz	230 V ~ 50 Hz
Rated input	1050 W	1050 W	1250 W
Idle speed	0 - 500 min <sup>-1</sup>	0 - 500 min <sup>-1</sup>	0 - 850 min <sup>-1</sup>
Blow rate	0 - 4100 min <sup>-1</sup>	0 - 4100 min <sup>-1</sup>	0 - 4100 min <sup>-1</sup>
Impact force	10.0 J	9.0 J	5.0 J
Drilling capacity, cement	40 mm	38 mm	32 mm
Drill chuck	SDS-max	SDS-max	SDS-plus
Product weight	6.9 kg	6.7 kg	5.7 kg
Speed control electronics	•	•	•
Vibration-cushioned main handle	•	•	•
Overload safety stop	•	•	•
Pneumatic impact mechanism	•	•	•
Functions	3	3	4
Lock for continuous operation	•	-	-
Service interval indicator	-	•	•
Additional handle	•	•	•
Metal depth stop	-	•	•
Accessories	2 SDS-max chisels	-	3 SDS-plus drill bits / 2 SDS-plus chisels
Packaging	E-Box	E-Box	E-Box
Article number	42.579.35	42.579.59	42.579.44



4 006825 655926



4 006825 663884



4 006825 650419

## ROTARY HAMMERS 5 KG CLASS

ANTI  
VIBRATION  
SYSTEM



	RT-RH 32 <b>EXPERT</b>	RT-RH 32 Kit <b>EXPERT</b>
Mains connection	230 V ~ 50 Hz	230 V ~ 50 Hz
Rated input	1250 W	1250 W
Idle speed	800 min <sup>-1</sup>	800 min <sup>-1</sup>
Blow rate	4300 min <sup>-1</sup>	4300 min <sup>-1</sup>
Impact force	3.5 J	3.5 J
Drilling capacity, cement	32 mm	32 mm
Drill chuck	SDS-plus	SDS-plus
Product weight	6.1 kg	6.1 kg
Speed control electronics	-	-
Vibration-cushioned main handle	•	•
Overload safety stop	•	•
Pneumatic impact mechanism	•	•
Functions	3	3
Lock for continuous operation	-	-
Service interval indicator	-	-
Additional handle	•	•
Metal depth stop	•	•
Accessories	3 SDS-plus drill bits / 2 SDS-plus chisels	13-piece drill bits / chisels set
Packaging	Case	Case
Article number	42.584.40	42.584.85



4 006825 537581



4 006825 578935

## ROTARY HAMMERS 5 KG CLASS



	<b>TC-RH 1600</b> <b>CLASSIC</b>	<b>TC-RH 900</b> <b>CLASSIC</b>
Mains connection	230 - 240 V ~ 50 Hz	230 V ~ 50 Hz
Rated input	1600 W	900 W
Idle speed	800 min <sup>-1</sup>	850 min <sup>-1</sup>
Blow rate	3900 min <sup>-1</sup>	4000 min <sup>-1</sup>
Impact force	4.0 J	3.0 J
Drilling capacity, cement	32 mm	26 mm
Drill chuck	SDS-plus	SDS-plus
Product weight	5.6 kg	4.1 kg
Speed control electronics	-	-
Vibration-cushioned main handle	•	-
Overload safety stop	•	•
Pneumatic impact mechanism	•	•
Functions	4	3
Lock for continuous operation	-	-
Service interval indicator	-	-
Additional handle	•	•
Metal depth stop	•	•
Accessories	-	-
Packaging	Case	Case
Article number	42.584.78	42.582.37





## DEMOLITION HAMMERS



	TP-DH 50 <b>PROFESSIONAL</b>	TC-DH 43 <b>CLASSIC</b>
Mains connection	220 - 240 V ~ 50 Hz	230 V ~ 50 Hz
Rated input	1700 W	1600 W
Blow rate	1800 min <sup>-1</sup>	1800 min <sup>-1</sup>
Impact force	50 J	43 J
Drill chuck	SDS-hex	SDS-hex
Product weight	18.4 kg	14.6 kg
Pneumatic impact mechanism	•	•
Vibration-cushioned main handle	•	-
Lock for continuous operation	•	-
Additional handle	•	•
Accessories	1 pointed chisel, 1 flat chisel	1 pointed chisel, 1 flat chisel
Packaging	E-Box trolley	Case
Article number	41.391.30	41.390.87



4 006825 630305



4 006825 638899

## DEMOLITION HAMMERS



	TE-DH 32 <b>EXPERT</b>	TE-DH 12 <b>EXPERT</b>	TE-DH 5 <b>EXPERT</b> <span style="float: right;"><b>NEW</b></span>
Mains connection	230 - 240 V ~ 50 Hz	220 - 240 V ~ 50-60 Hz	220 - 240 V ~ 50 Hz
Rated input	1500 W	1050 W	750 W
Blow rate	1900 min <sup>-1</sup>	4100 min <sup>-1</sup>	4300 min <sup>-1</sup>
Impact force	32 J	12 J	5 J
Drill chuck	SDS-max	SDS-max	SDS-plus
Product weight	10.8 kg	6.8 kg	3.5 kg
Pneumatic impact mechanism	•	•	•
Vibration-cushioned main handle	•	•	•
Lock for continuous operation	•	•	•
Additional handle	•	•	•
Accessories	1 pointed chisel, 1 flat chisel	1 pointed chisel, 1 flat chisel	1 pointed chisel, 1 flat chisel
Packaging	E-Box	E-Box	E-Box Basic
Article number	41.390.99	41.391.00	41.391.35



4 006825 650334



4 006825 625219



4 006825 657555

## PAINT/MORTAR MIXERS



	<b>TE-MX 1600-2 CE Twin</b> <b>EXPERT</b>	<b>TE-MX 1600-2 CE</b> <b>EXPERT</b>
Mains connection	220 - 240 V ~ 50 Hz	220 - 240 V ~ 50 Hz
Rated input	1600 W	1600 W
Idle speed	180 - 460 / 300 - 750 min <sup>-1</sup>	0 - 460 / 0 - 750 min <sup>-1</sup>
Stirrer mount	Hex 13 mm	M14
Product weight	3.7 kg (excl. stirrers)	3.5 kg (excl. stirrer)
Speed control electronics	•	•
Constant electronics	•	•
Soft start	•	•
Shaft mount for stationary operation	•	•
Soft grip	•	•
Accessories	Mortar twin stirrers (Ø 120 mm)	1 mortar stirrer (Ø 133 mm)
Packaging	Colour box	Colour box
Article number	42.585.61	42.585.55



4 006825 614558



4 006825 602258

## PAINT/MORTAR MIXERS



	<b>TC-MX 1400-2 E</b> <b>CLASSIC</b>	<b>TC-MX 1200 E</b> <b>CLASSIC</b>
Mains connection	220 - 240 V ~ 50 Hz	220 - 240 V ~ 50 Hz
Rated input	1400 W	1200 W
Idle speed	0 - 480 / 0 - 780 min <sup>-1</sup>	0 - 680 min <sup>-1</sup>
Stirrer mount	M14	M14
Product weight	3.5 kg (excl. stirrer)	3.2 kg (excl. stirrer)
Speed control electronics	•	•
Constant electronics	-	-
Soft start	•	•
Shaft mount for stationary operation	•	•
Soft grip	•	-
Accessories	1 mortar stirrer (Ø 133 mm)	1 mortar stirrer (Ø 100 mm)
Packaging	Colour box	Colour box
Article number	42.585.50	42.585.45



4 006825 602241



4 006825 616620

## ANGLE GRINDERS 230 MM



	TE-AG 230 <b>EXPERT</b>	TE-AG 230/2000 <b>EXPERT</b>
Mains connection	230 V ~ 50 Hz	230 V ~ 50 Hz
Rated input	2350 W	2000 W
Idle speed	6500 min <sup>-1</sup>	6500 min <sup>-1</sup>
Wheel diameter	230 mm	230 mm
Product weight	6.0 kg	5.4 kg
Disc guard with quick adjust facility	•	•
Spindle Lock	•	•
Soft grip	•	•
Additional handle	can be mounted in 3 positions	can be mounted in 3 positions
Soft start	•	•
Vibration-cushioned main handle	•	-
Swivel handle	•	-
Face spanner	•	•
Accessories	-	-
Packaging	Colour box	Colour box
Article number	44.308.70	44.308.40



## ANGLE GRINDERS 125 MM



	TE-AG 125 CE <b>EXPERT</b>	TE-AG 125/1010 CE Q <b>EXPERT</b>
Mains connection	220 - 240 V ~ 50 Hz	220 - 240 V ~ 50 Hz
Rated input	1100 W	1010 W
Idle speed	3000 - 12000 min <sup>-1</sup>	4000 - 12000 min <sup>-1</sup>
Wheel diameter	125 mm	125 mm
Product weight	2.5 kg	2.0 kg
Constant electronics	•	•
Restart safeguard	-	•
Safety switch	•	•
Disc guard with quick adjust facility	•	•
Spindle Lock	•	•
Soft grip	•	•
Additional handle	can be mounted in 3 positions	can be mounted in 2 positions
Soft start	•	•
LED operating status indicator	•	-
Face spanner	•	-
Accessories	-	Quick fix nut
Packaging	Colour box	Colour box
Article number	44.308.60	44.308.90



## ANGLE GRINDERS 125 MM



	TE-AG 125/750 <b>EXPERT</b>	TC-AG 125/850 <b>CLASSIC</b>	TC-AG 125/850 Kit <b>CLASSIC</b> <span style="float: right;"><b>NEW</b></span>
Mains connection	230 V ~ 50 Hz	220 - 240 V ~ 50 Hz	220 - 240 V ~ 50 Hz
Rated input	750 W	850 W	850 W
Idle speed	12000 min <sup>-1</sup>	12000 min <sup>-1</sup>	12000 min <sup>-1</sup>
Wheel diameter	125 mm	125 mm	125 mm
Product weight	1.9 kg	1.6 kg	1.6 kg
Constant electronics	-	-	-
Restart safeguard	•	•	•
Safety switch	•	•	•
Disc guard with quick adjust facility	•	-	-
Spindle Lock	•	•	•
Soft grip	•	•	•
Additional handle	can be mounted in 3 positions	can be mounted in 2 positions	can be mounted in 2 positions
Soft start	-	•	•
LED operating status indicator	-	-	-
Face spanner	•	•	•
Accessories	-	-	3 cutting wheels, grinding disc, 1 cutting wheel guard
Packaging	Colour box	Colour box	Einhell Bag 45/22
Article number	44.308.80	44.309.71	44.309.77



## ANGLE GRINDER 115 MM



	TC-AG 115/750 <b>CLASSIC</b>
Mains connection	220 - 240 V ~ 50 Hz
Rated input	750 W
Idle speed	12000 min <sup>-1</sup>
Wheel diameter	115 mm
Product weight	1.7 kg
Restart safeguard	•
Safety switch	•
Disc guard with quick adjust facility	-
Spindle Lock	•
Soft grip	•
Additional handle	can be mounted in 2 positions
Soft start	•
Cable clip	-
Face spanner	•
Accessories	-
Packaging	Colour box
Article number	44.309.60



## WALL LINERS



	TE-MA 1700 <b>EXPERT</b> <small>NEW</small>	TE-MA 1500 <b>EXPERT</b> <small>NEW</small>	TC-MA 1300 <b>CLASSIC</b>
Mains connection	220 - 240 V ~ 50 Hz	220 - 240 V ~ 50 Hz	230 V ~ 50 Hz
Rated input	1700 W	1500 W	1320 W
Idle speed	7000 min <sup>-1</sup>	8500 min <sup>-1</sup>	9000 min <sup>-1</sup>
Cutting wheel	Ø 150 x Ø 22 mm	Ø 125 x Ø 22 mm	Ø 125 x Ø 22.2 mm
Channel depth	8 - 40 mm	5- 30 mm	8 - 30 mm
Channel width	8 - 38 mm	8 - 30 mm	8 - 26 mm
Spindle thread	M14	M14	M14
Product weight	5.8 kg	4.8 kg	4.9 kg
Infinitely adjustable cutting depth	•	•	•
Overload cut-out	•	•	•
Soft start	•	•	•
Spindle Lock	•	•	•
Dust extraction	•	•	•
Diamond cutting wheel	4 pcs	2 pcs	2 pcs
Storage case	•	•	-
Packaging	Colour box	Colour box	Colour box
Article number	43.507.40	43.507.35	43.507.30



4 006825 659146



4 006825 659139



4 006825 593044

## BISCUIT JOINER



	TC-BJ 900 <b>CLASSIC</b>
Mains connection	230 V ~ 50 Hz
Rated input	860 W
Idle speed	11000 min <sup>-1</sup>
Max. cutting depth	14 mm
Tilt angle adjustment	90°
Channel cutter	Ø 100 x Ø 22 x 3.8 mm
Product weight	3.3 kg
Infinitely adjustable angle setting	•
Infinitely adjustable height	•
Cutting depth quick-set adjustment	3 settings
Spindle Lock	•
Dust extraction	by use of dust bag
Face spanner	•
Packaging	Colour box
Article number	43.506.20



4 006825 604313

## ROUTERS



	<b>TE-RO 1255 E</b> <b>EXPERT</b>	<b>TC-RO 1155 E</b> <b>CLASSIC</b>
Mains connection	230 V ~ 50 Hz	230 - 240 V ~ 50 Hz
Rated input	1200 W	1100 W
Idle speed	11000 - 30000 min <sup>-1</sup>	11000 - 30000 min <sup>-1</sup>
Stroke height	55 mm	55 mm
Max. form cutter	30 mm	30 mm
Product weight	3.3 kg	3.0 kg
Speed control electronics	•	•
Cutting depth fine adjustment	•	•
Chip shield	•	•
Spindle Lock	•	•
Soft grip	•	-
Cable clip	•	-
Parallel stop	•	•
Compass point	•	•
Copy sleeve	•	•
Clamp diameter	6 mm / 8 mm	6 mm / 8 mm
Packaging	Colour box	Colour box
Article number	43.504.90	43.504.70



## PLANERS



	<b>TE-PL 900</b> <b>EXPERT</b>	<b>TC-PL 750</b> <b>CLASSIC</b>
Mains connection	230 V ~ 50 Hz	220 - 240 V ~ 50 Hz
Rated input	900 W	750 W
Idle speed	15000 min <sup>-1</sup>	17000 min <sup>-1</sup>
Planing width	82 mm	82 mm
Chip depth	3 mm	2 mm
Rebate depth	18 mm	10 mm
Product weight	3.6 kg	2.4 kg
Soft grip	•	•
Automatic blade protector	•	•
Aluminium sole plates	•	•
V grooves	3 pcs	1 pc
Chip ejection	double-sided	on one side
Cable clip	•	-
Parallel stop	•	•
Rebate depth stop	•	•
Planing blades (reversible blades)	1 pair TCT	1 pair TCT
Packaging	Colour box	Colour box
Article number	43.453.20	43.453.10



## JIGSAWS



	<b>TC-JS 85</b> <b>CLASSIC</b>	<b>TC-JS 80/1</b> <b>CLASSIC</b>
Mains connection	230 V ~ 50 Hz	220 - 240 V ~ 50/60 Hz
Rated input	620 W	550 W
Stroke speed	800 - 3000 min <sup>-1</sup>	1000 - 3000 min <sup>-1</sup>
Cutting depth (wood/plastic/steel)	85 / 12 / 8 mm	80 / 12 / 10 mm
Product weight	2.0 kg	1.9 kg
Universal blade holder	-	-
Pendulum action	4 settings	4 settings
Cutting angle adjustment without tools	•	-
Blade change without tools	•	•
Vacuum cleaner connection	•	•
LED	-	-
Dust-blower function	•	-
Cutting line guide	-	-
Saw blades	1 pc (wood)	-
Accessories	Parallel stop, chip guard	-
Packaging	Colour box	Colour box
Article number	43.211.40	43.211.45



4 006825 576573



4 006825 619737

## JIGSAWS



	<b>TC-JS 60/1</b> <b>CLASSIC</b>
Mains connection	220 - 240 V ~ 50 Hz
Rated input	400 W
Stroke speed	1000 - 3000 min <sup>-1</sup>
Cutting depth (wood/plastic/steel)	60 / 10 / 6 mm
Product weight	1.7 kg
Universal blade holder	-
Pendulum action	-
Cutting angle adjustment without tools	-
Blade change without tools	•
Vacuum cleaner connection	•
LED	-
Dust-blower function	-
Cutting line guide	-
Saw blades	-
Accessories	-
Packaging	Colour box
Article number	43.211.35



4 006825 619720

## CIRCULAR SAWS



	<b>TE-CS 190/1</b> <b>EXPERT</b>	<b>TC-CS 1410</b> <b>CLASSIC</b>
Mains connection	230 V ~ 50 Hz	220 - 240 V ~ 50 Hz
Rated input	1500 W	1410 W
Idle speed	5500 min <sup>-1</sup>	5500 min <sup>-1</sup>
Saw blade	Ø 190 x Ø 30 mm	Ø 190 x Ø 30 mm
Cutting depth 90°	66 mm	67 mm
Cutting depth 45°	48 mm	46 mm
Product weight	5.2 kg	4.3 kg
Adjustment without tools (depth/angle)	•	•
LED	•	-
Aluminium sawing table	•	-
Spindle Lock	•	•
Double-sided safety lock-off	•	•
Dust extraction device	•	•
Soft grip	•	•
Accessories	Parallel stop	Parallel stop
Packaging	Colour box	Colour box
Article number	43.310.05	43.310.50



## CIRCULAR SAWS



	<b>TE-CS 165</b> <b>EXPERT</b>	<b>TC-CS 1250</b> <b>CLASSIC</b>
Mains connection	230 V ~ 50 Hz	220 - 240 V ~ 50 Hz
Rated input	1200 W	1250 W
Idle speed	5500 min <sup>-1</sup>	5500 min <sup>-1</sup>
Saw blade	Ø 165 x Ø 16 mm	Ø 165 x Ø 16 mm
Cutting depth 90°	55 mm	55 mm
Cutting depth 45°	40 mm	38 mm
Product weight	3.8 kg	3.8 kg
Adjustment without tools (depth/angle)	•	•
LED	-	-
Aluminium sawing table	•	-
Spindle Lock	•	•
Double-sided safety lock-off	•	•
Dust extraction device	•	•
Soft grip	•	•
Accessories	Parallel stop	Parallel stop
Packaging	Colour box	Colour box
Article number	43.310.10	43.310.40





## PLUNGE CUT SAW



	<b>TE-PS 165</b> <b>EXPERT</b>
Mains connection	220 - 240 V ~ 50 Hz
Rated input	1200 W
Idle speed	5200 min <sup>-1</sup>
Saw blade	Ø 165 x Ø 20 mm
Cutting depth 90°	56 mm
Cutting depth 45°	42 mm
Product weight	4.8 kg
Adjustment without tools (depth/angle)	•
LED	-
Aluminium sawing table	•
Spindle Lock	•
Dust extraction device	•
Soft grip	•
Cutting line guide	•
Accessories	Parallel stop
Packaging	Colour box
Article number	43.313.00



**THE RIGHT  
GUIDE  
BAR  
FOR THE  
PLUNGE  
CUT SAW**  
CAN BE FOUND  
ON PAGE 142

## MINI CIRCULAR SAW



	<b>TC-CS 89</b> <b>CLASSIC</b>
Mains connection	220 - 240 V ~ 50 Hz
Rated input	600 W
Idle speed	7200 min <sup>-1</sup>
Saw blade	Ø 89 x Ø 10 mm
Cutting depth	27 mm
Product weight	2.0 kg
Cutting depth adjustment without tools	•
Aluminium sawing table	•
Dust extraction adapter	•
Soft grip	•
Accessories	2 saw blades (wood/plastic), 1 diamond cutting wheel, parallel stop
Packaging	Colour box
Article number	43.310.30



## ALL PURPOSE SAWS



	<b>TE-AP 950 E</b> <b>EXPERT</b>	<b>TE-AP 750 E</b> <b>EXPERT</b>	<b>TC-AP 690 E</b> <b>CLASSIC</b> <span style="float: right;"><b>NEW</b></span>
Mains connection	220 - 240 V ~ 50 Hz	220 - 240 V ~ 50 Hz	220 - 240 V ~ 50 Hz
Rated input	950 W	750 W	690 W
Stroke speed	0 - 2500 min <sup>-1</sup>	0 - 2800 min <sup>-1</sup>	0 - 2800 min <sup>-1</sup>
Stroke height	28 mm	20 mm	20 mm
Cutting depth (wood / steel)	200 / 20 mm	150 / 10 mm	115 / 10 mm
Saw blade thickness	0.8 - 1.5 mm	0.8 - 1.5 mm	0.8 - 1.5 mm
Product weight	3.2 kg	2.4 kg	2.2 kg
Blade change without tools	•	•	•
Soleplate adjustment without tools	•	•	-
Soft grip	•	•	•
Accessories	1 kwb saw blade	1 kwb saw blade	1 saw blade (wood)
Packaging	Colour box	Colour box	Colour box
Article number	43.261.80	43.261.70	43.261.61



4 006825 632699



4 006825 632682



4 006825 661170



## MULTIFUNCTIONAL TOOLS



	<b>TE-MG 300 EQ</b> <b>EXPERT</b>	<b>TE-MG 200 CE</b> <b>EXPERT</b>	<b>TC-MG 220/1 E</b> <b>CLASSIC</b>
Mains connection	230 - 240 V ~ 50 Hz	230 V ~ 50 Hz	220 - 240 V ~ 50 Hz
Rated input	300 W	200 W	220 W
Oscillating speed / idle speed	22000 - 40000 min <sup>-1</sup> / 11000 - 20000 min <sup>-1</sup>	30000 - 42000 min <sup>-1</sup> / 15000 - 21000 min <sup>-1</sup>	22000 - 44000 min <sup>-1</sup> / 11000 - 22000 min <sup>-1</sup>
Oscillation angle	3.2°	3.0°	3.2°
Abrasive paper size	93 x 93 x 93 mm	93 x 93 x 93 mm	93 x 93 x 93 mm
Product weight	1.5 kg	1.1 kg	1.3 kg
Speed control electronics	•	•	•
Constant electronics	•	•	-
Soft grip	•	•	•
Quick-release lock	•	-	-
Magnetic tool mounting	•	-	•
Delta grinding/sanding disc	•	•	•
Abrasive paper	3x P60, 3x P120	3x P60, 3x P120	1x P60
Scraper	•	•	•
Plunge-cut blades	Wood/plastic, metal (1x each)	1x wood/plastic	1x wood/plastic
Segment saw blades	Wood/plastic/non-ferrous metal, tile joints (1x each)	-	-
Dust extraction adapter	•	•	•
Hex key	-	•	•
Packaging	Colour box	Colour box	Colour box
Article number	44.651.50	44.650.40	44.650.95



4 006825 614237



4 006825 577204



4 006825 626490

## CORDLESS MULTIFUNCTIONAL TOOL

**12 V**  
**POWER**

	<b>TE-MG 12/1 Li (1x 2.0 Ah)</b> <b>EXPERT</b>
Battery voltage / capacity	12 V / 2.0 Ah
Charging time	45 min
Oscillating speed / idle speed	10000 - 33000 min <sup>-1</sup> / 5000 - 16500 min <sup>-1</sup>
Oscillation angle	2.8°
Abrasive paper size	93 x 93 x 93 mm
Product weight	1.0 kg (excl. battery)
Speed control electronics	•
Soft grip	•
Number of batteries / number of chargers	1 / 1x 45 min charger
Delta grinding/sanding disc	•
Abrasive paper	2x P60, 2x P80, 2x P120
Scraper	•
Plunge-cut blades	1x wood/plastic
Segment saw blades	1x wood/plastic/non-ferrous metal
Hex key	-
Packaging	Colour box
Article number	44.651.80



4 006825 630336

## CORDLESS GRINDING AND ENGRAVING TOOL



	<b>TE-MT 7.2 Li</b> <b>EXPERT</b>
Battery voltage / capacity	7.2 V / 1.5 Ah
Charging time	1 h
Idle speed	5500 - 26000 min <sup>-1</sup>
Clamping sleeves, Ø	1.6 mm / 2.4 mm / 3.2 mm
Product weight	0.3 kg
Speed control electronics	•
Spindle Lock	•
Soft grip	•
Charging station	•
Accessories Set	57-piece
Packaging	Storage carton with magnetic lock
Article number	44.193.30



4 006825 639353

## GRINDING AND ENGRAVING TOOL



	<b>TC-MG 135 E</b> <b>CLASSIC</b>
Mains connection	230 V ~ 50 Hz
Rated input	135 W
Idle speed	10000 - 35000 min <sup>-1</sup>
Clamping sleeves, Ø	0.5 / 1.6 / 2.4 / 3.2 mm
Product weight	0.7 kg
Speed control electronics	•
Spindle Lock	•
Soft grip	•
Accessories Set	189-piece accessory set in storage case
Telescopic stand	•
Flexible shaft	•
Packaging	Case
Article number	44.191.69



4 006825 585315

## ORBITAL SANDERS



	<b>TE-OS 2520 E</b> <b>EXPERT</b>	<b>TC-OS 1520</b> <b>CLASSIC</b>
Mains connection	230 V - 50 Hz	230 V - 50 Hz
Rated input	250 W	150 W
Oscillating speed	14000 - 24000 min <sup>-1</sup>	23000 min <sup>-1</sup>
Oscillating circuit, Ø	2.0 mm	2.0 mm
Grinding/sanding area	230 x 115 mm	187 x 90 mm
Abrasive paper size, hook and loop fastening system	230 x 115 mm	187 x 93 mm
Abrasive paper size, clamping mechanism	280 x 115 mm	230 x 93 mm
Product weight	1.9 kg	1.1 kg
Speed control electronics	•	-
Hook and loop fastening system	•	•
Clamping mechanism	•	•
Dust extraction	by use of dust collection box & dust extraction adapter	by use of dust extraction adapter
Low Vibration	•	-
Aluminium sole plate	•	-
Soft grip	•	•
Abrasive paper	1x P120	3x P120
Packaging	Colour box	Colour box
Article number	44.606.20	44.606.40



## BAND SANDERS



	<b>TE-BS 8540 E</b> <b>EXPERT</b>	<b>TC-BS 8038</b> <b>CLASSIC</b>
Mains connection	230 V - 50 Hz	230 V - 50 Hz
Rated input	850 W	800 W
Grinding/sanding belt speed	300 - 400 m/min	380 m/min
Grinding/sanding area	75 x 140 mm	76 x 142 mm
Grinding/sanding belt size	75 x 533 mm	76 x 533 mm
Product weight	3.1 kg	3.4 kg
Belt run adjustment	•	•
Belt change without tools	•	•
Dust extraction	by use of dust collection box & dust extraction adapter	by use of dust collection box & dust extraction adapter
Soft grip	•	-
Additional handle	•	•
Folding front cover	•	-
Cable clip	•	-
Sanding/grinding belt	1x P80	1x P80
Packaging	Colour box	Colour box
Article number	44.662.30	44.662.60



## DELTA SANDERS



	<b>TE-DS 20 E</b> <b>EXPERT</b>	<b>TC-DS 19</b> <b>CLASSIC</b>
Mains connection	230 V ~ 50 Hz	230 V ~ 50 Hz
Rated input	200 W	190 W
Oscillating speed	13000 - 20000 min <sup>-1</sup>	20000 min <sup>-1</sup>
Oscillating circuit, Ø	2.0 mm	1.2 mm
Abrasive paper size	93 x 93 x 93 mm	93 x 93 x 93 mm
Product weight	1.2 kg	1.1 kg
Speed control electronics	•	-
Soft grip	•	-
Hook and loop fastening system	•	-
Dust extraction	by use of dust extraction adapter	by use of dust extraction adapter
Soft start	•	-
Cable clip	•	-
Abrasive paper	5x P80, 5x P120	1x P60, 1x P80, 1x P120
Dust extraction adapter	•	•
Packaging	Colour box	Colour box
Article number	44.642.50	44.642.35



## MULTI SANDERS



	<b>TE-OS 1320</b> <b>EXPERT</b>	<b>TH-OS 1016</b> <b>CLASSIC</b>
Mains connection	230 V ~ 50 Hz	230 V ~ 50 Hz
Rated input	130 W	100 W
Oscillating speed	24000 min <sup>-1</sup>	24000 min <sup>-1</sup>
Oscillating circuit, Ø	2.0 mm	1.6 mm
Abrasive paper size	150 x 150 x 100 mm	150 x 150 x 100 mm
Product weight	1.2 kg	1.0 kg
Soft grip	•	•
Hook and loop fastening system	•	•
Dust extraction	by use of dust collection box & dust extraction adapter	by use of dust bag + dust extraction adapter
Cable clip	•	-
Abrasive paper	3x P120	1x P120
Packaging	Colour box	Colour box
Article number	44.605.60	44.606.10



## ROTATING SANDERS



	TE-RS 40 E <b>EXPERT</b>	TC-RS 38 E <b>CLASSIC</b>
Mains connection	230 V - 50 Hz	230 V - 50 Hz
Rated input	400 W	380 W
Oscillating speed	12000 - 24000 min <sup>-1</sup>	12000 - 26000 min <sup>-1</sup>
Oscillating circuit, Ø	2.5 mm	2.0 mm
Abrasive paper, Ø	125 mm	125 mm
Product weight	2.1 kg	2.0 kg
Speed control electronics	•	•
Hook and loop fastening system	•	•
Dust extraction	by use of dust collection box & dust extraction adapter	by use of dust bag + dust extraction adapter
Soft grip	•	-
Additional handle	•	-
Low Vibration	•	-
Abrasive paper	-	1x P80
Packaging	Colour box	Colour box
Article number	44.620.00	44.621.65



4 006825 590661



4 006825 603811

## WALL AND CONCRETE GRINDER



	TE-DW 180 <b>EXPERT</b>
Mains connection	230 - 240 V - 50 Hz
Rated input	1300 W
Idle speed	800 - 1750 min <sup>-1</sup>
Abrasive paper dimensions	Ø 180 mm
Device length	-
Hose length	-
Cable length	4.0 m
Product weight	3.3 kg
Speed control electronics	•
Adjustable grinding head	•
Round sanding/grinding disc	•
Delta sanding/grinding disc	-
Diamond cup wheel	•
Steel brushes	•
Folding and height-adjustable long handle	-
Supporting foot	-
Round sanding discs	2x P60, 2x P80, 2x P120
Triangular sanding discs	-
Round abrasive mesh	-
Delta abrasive mesh	-
Packaging	Colour box
Article number	42.599.40



4 006825 632750

## DRYWALL POLISHERS

**EASY HANDLING**



	<b>TE-DW 225 X</b> <b>EXPERT</b>	<b>TC-DW 225</b> <b>CLASSIC</b>
Mains connection	230 - 240 V ~ 50 Hz	230 - 240 V ~ 50 Hz
Rated input	750 W	600 W
Idle speed	600 - 1800 min <sup>-1</sup>	600 - 1500 min <sup>-1</sup>
Abrasive paper dimensions	Ø 225 mm / 285 x 285 x 285 mm	Ø 225 mm
Device length	110 - 165 cm	110 - 165 cm
Hose length	4.0 m	4.0 m
Cable length	4.0 m	4.0 m
Product weight	3.7 kg	3.2 kg
Speed control electronics	•	•
Adjustable grinding head	•	•
Round sanding/grinding disc	•	•
Delta sanding/grinding disc	•	-
Diamond cup wheel	-	-
Steel brushes	-	-
Folding and height-adjustable long handle	•	•
Supporting foot	•	•
Round sanding discs	1x P60, 1x P80, 1x P120	2x P60, 2x P80, 2x P120
Triangular sanding discs	1x P60, 1x P80, 1x P120	-
Round abrasive mesh	1x P80	-
Delta abrasive mesh	1x P80	-
Packaging	E-Box	Case
Article number	42.599.60	42.599.30





## ELECTRIC PAINT SPRAY SYSTEMS (SEMI-STATIONARY)



	TC-SY 700 S <b>CLASSIC</b>	TC-SY 600 S <b>CLASSIC</b>
Mains connection	220 - 240 V ~ 50 Hz	220 - 240 V ~ 50 Hz
Rated input	700 W	600 W
Delivery rate	1000 ml/min	1000 ml/min
Tank volume	1000 ml	800 ml
Hose length	3.5 m	1.8 m
Product weight	3.0 kg	2.3 kg
Processing	Lacquers, glazes, interior wall paints	Lacquers, glazes, interior wall paints
Removable spray cap	•	•
Control of the paint delivery rate	•	•
Paint jet	Vertical, horizontal and round jet	Vertical, horizontal and round jet
Soft grip	•	•
Shoulder strap	•	•
Slide	•	-
Spray nozzles	Ø 2.5 mm, Ø 3.0 mm	Ø 2.5 mm, Ø 3.0 mm
Cleaning brush and needle	•	•
Tank for testing the viscosity	•	•
Paint tank with cover	1000 ml	800 ml
Packaging	Colour box	Colour box
Article number	42.600.20	42.600.15



4 006825 614596



4 006825 614572

## ELECTRIC PAINT SPRAY SYSTEMS (SPRAY GUN)



	TC-SY 500 P <b>CLASSIC</b>	TC-SY 400 P <b>CLASSIC</b>
Mains connection	220 - 240 V ~ 50 Hz	220 - 240 V ~ 50 Hz
Rated input	500 W	400 W
Delivery rate	550 ml/min	500 ml/min
Tank volume	1000 ml	800 ml
Product weight	1.3 kg	1.3 kg
Processing	Lacquers, glazes	Lacquers, glazes
Removable spray cap	•	•
Control of the paint delivery rate	•	•
Paint jet	Vertical, horizontal and round jet	Vertical, horizontal and round jet
Soft grip	•	•
Suspension fixture	•	•
Spray nozzles	Ø 2.0 mm, Ø 2.5 mm	Ø 2.0 mm, Ø 2.5 mm
Cleaning brush and needle	•	•
Tank for testing the viscosity	•	•
Paint tank with cover	1000 ml	800 ml
Packaging	Colour box	Colour box
Article number	42.600.10	42.600.05



4 006825 613780



4 006825 613773

## HOT GLUE GUN



	<b>TC-GG 30</b> <b>CLASSIC</b>
Mains connection	220 - 240 V ~ 50 Hz
Rated input	30 W
Warm-up period	300 s
Max. temperature	195 °C
Glue stick diameter	11 mm
Glue stick length	150 mm
Product weight	0.2 kg
Mechanical glue stick feeding	•
Viewing window	•
Support bar	•
Glue sticks	3 pcs
Standard nozzle	•
Flat nozzle	•
Extension nozzle	•
Packaging	Colour box
Article number	45.221.70



4 006825 614022

## CORDLESS HOT GLUE GUN



	<b>TC-CG 3.6/1 Li</b> <b>CLASSIC</b>
Li-Ion Battery Pack voltage / capacity	3.6 V / 1.5 Ah
Charging time	3 - 5 h
Warm-up period	30 s
Max. temperature	160 °C
Glue stick diameter	7 mm
Glue stick length	150 mm
Product weight	0.3 kg
LED status indicator	•
Mechanical glue stick feeding	•
Support bar	•
Accessories	4 glue sticks
Packaging	Metal box
Article number	45.221.90



4 006825 637854

## ELECTRIC TACKER



	<b>TC-EN 20 E</b> <b>CLASSIC</b>
Mains connection	220 - 240 V ~ 50 Hz
Shots per minute	20
Staples type	53
Staple length	6 - 14 mm
Staple width	11.4 mm
Staple size	0.75 mm
Nail type	47
Nail length	14 mm
Nail size	1.16 - 1.26 mm
Product weight	1.1 kg
Safety lug	•
Soft grip	•
Magazine level indication	•
Impact force preset	•
Staples (type 53)	1000 pcs
Nails (type 47)	500 pcs
Packaging	Colour box
Article number	42.578.90



4 006825 615647

## CORDLESS TACKER



	<b>TC-CT 3.6 Li</b> <b>CLASSIC</b>
Battery voltage	3.6 V
Battery capacity	1.3 Ah
Charging time	3 - 5 h
Shots per minute	30
Staples type	53
Staple length	6 - 14 mm
Staple width	11.4 mm
Staple size	0.75 mm
Product weight	0.9 kg
Safety lug	•
Soft grip	•
Magazine level indication	•
Charge status indicator	•
Staples (type 53)	1000 pcs
Battery charger	•
Packaging	Metal box
Article number	42.578.80



4 006825 607291

## HOT AIR GUNS



	<b>TE-HA 2000 E</b> <b>EXPERT</b>
Mains voltage	220 - 240 V ~ 50 Hz
Rated input	2000 W
Air rate	250 / 250 / 500 l/min
Temperature	50 / 50 - 550 / 50 - 550 °C
Product weight	0.9 kg
Air rate and temperature control system	3 settings
Cold setting	•
Ceramic heater	•
Overheating guard	•
Storage area	•
Temperature adjustment, 9 levels	•
Wide nozzle	•
Reducer nozzle	•
Reflector nozzle	•
Heat nozzle	•
Paint scraper	-
Packaging	Colour box
Article number	45.201.95



4 006825 602678

## HOT AIR GUNS



	<b>TH-HA 2000/1</b> <b>CLASSIC</b>	<b>TC-HA 2000/1</b> <b>CLASSIC</b>
Mains voltage	230 / 240 V ~ 50 Hz	230 / 240 V ~ 50 Hz
Rated input	2000 W	2000 W
Air rate	300 / 500 l/min	300 / 500 l/min
Temperature	350 / 550 °C	350 / 550 °C
Product weight	0.7 kg	0.7 kg
Air rate and temperature control system	2 settings	2 settings
Cold setting	-	-
Ceramic heater	-	-
Overheating guard	•	•
Storage area	•	•
Temperature adjustment, 9 levels	-	-
Wide nozzle	•	•
Reducer nozzle	•	•
Reflector nozzle	•	-
Heat nozzle	•	-
Paint scraper	•	-
Packaging	Colour box	Colour box
Article number	45.201.79	45.201.84



4 006825 593235



4 006825 602227

## 360° CROSS LASER LEVEL



	<b>TE-LL 360</b> <b>EXPERT</b>
Laser diode	650 nm (horizontal), 635 nm (vertical)
Laser class	2
Work area Ø	20 m
Precision	+/- 0.4 mm/m
Self-levelling time	< 5 s
Levelling range	+/- 4°
Tripod socket	1/4"
Product weight	0.3 kg
Laser crosshair	•
Horizontal and/or vertical laser line	•
Horizontal 360° laser line	•
Self-levelling	•
Digital spirit level	•
Soft grip	•
Storage case	•
Height-adjustable wall mount	•
Universal clamp	-
Batteries	-
Packaging	Colour box
Article number	22.701.10



## CROSS LASER LEVELS IN ACTION

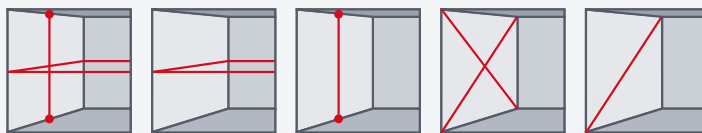

### FUNCTIONS

- 1** Levelling function: The Einhell cross-line laser helps make easy work of placing objects at the same level.
- 2** Einhell cross-line laser project a vertical and a horizontal laser line simultaneously, which you can use to make easy work of aligning objects exactly and uniformly.
- 3** The TE-LL 360 projects a horizontal 360° line for effortless and precise alignment of objects in a room.

## CROSS LASER LEVEL



	<b>TC-LL 2 CLASSIC</b>
Laser diode	635 nm
Laser class	2
Work area	8 m
Precision	+/- 0.5 mm/m
Self-levelling time	< 5 s
Levelling range	+/- 4°
Tripod socket	1/4"
Product weight	0.2 kg
Laser crosshair	•
Horizontal and/or vertical laser line	•
Horizontal 360° laser line	-
Self-levelling	•
Digital spirit level	•
Soft grip	•
Storage case	•
Height-adjustable wall mount	-
Universal clamp	•
Batteries	-
Packaging	Colour box
Article number	22.701.05



4 006825 616231



## LASER DISTANCE METERS



	<b>TC-LD 50 CLASSIC</b>	<b>TC-LD 25 CLASSIC</b>
Laser diode	635 nm	635 nm
Laser class	2	2
Measuring range	0.05 - 50 m	0.05 - 25 m
Measurement accuracy	+/- 2.0 mm/m	+/- 3.0 mm/m
Switches off automatically	from 3 min	from 3 min
Measurement reference	Front edge, back edge or stop plate	Front edge or back edge
Product weight	0.1 kg	0.1 kg
Measurement of lengths, areas and volumes	•	•
Addition and subtraction	of lengths, areas and volumes	-
Continuous measurements with min/max function	•	•
Safety function	•	•
Pythagoras function	•	-
Disconnection function	•	-
Last measurements are saved automatically	20	-
Soft grip	•	•
Storage case	•	•
Batteries	-	-
Packaging	Colour box	Colour box
Article number	22.700.80	22.700.75



4 006825 616194



4 006825 616187

### LASER DISTANCE METERS IN ACTION.

- 1** Simple measurement of areas, e.g. to determine the amount of wall paint needed.
- 2** Pitch function: Ability to create predefined uniform spacing using the pitch function, e.g. for determining the correct spacing between fence or railing posts.
- 3** Simple measurement of distances, e.g. to determine the amount of skirting boards needed.
- 4** Simple measurement of volumes, e.g. to determine room volumes for HVAC systems.
- 5** Indirect determination of heights and lengths in places that are difficult or impossible to access using the Pythagoras function (see picture below right).

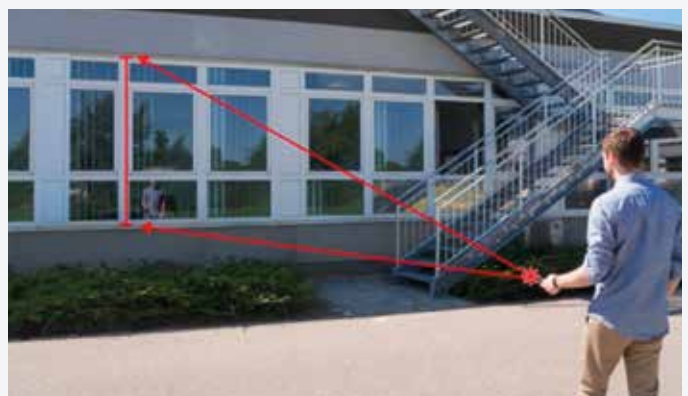

## LASER LEVELLING



	<b>TC-LL 1</b> <b>CLASSIC</b>
Laser diode	650 nm
Laser class	2
Work area	Laser line: 5 m, laser dot: 20 m
Precision	+/- 0.5 mm/m
Product weight	0.1 kg
Spirit level function	•
Soft grip	•
Flexible wall mount	•
Batteries	-
Packaging	Colour box
Article number	22.700.95



4 006825 616217

## DIGITAL DETECTOR



	<b>TC-MD 50</b> <b>CLASSIC</b>
Max. scanning depth: wood	19 mm
Max. scanning depth: non-ferrous metals	19 mm
Max. scanning depth: ferrous metals	50 mm
Max. scanning depth: copper	38 mm
Max. scanning depth: live wires	50 mm
Switches off automatically	from 1 min
Product weight	0.1 kg
Acoustic warning signal	•
Wall protection	•
Soft grip	•
Batteries	-
Packaging	Colour box
Article number	22.700.90



4 006825 616200





# STATIONARY POWER TOOLS



## SLIDING MITRE SAWS



	<b>TE-SM 254 Dual</b> <b>EXPERT</b>	<b>TE-SM 2534 Dual</b> <b>EXPERT</b>
Mains connection	220 - 240 V ~ 50 Hz	230 - 240 V ~ 50 Hz
Rated input	2100 W S6 25%	1800 W S1
Speed	4800 min <sup>-1</sup>	5100 min <sup>-1</sup>
Saw blade	Ø 254 x Ø 30 mm	Ø 250 x Ø 30 mm
Number of teeth	60	48
Swivelling range	-47° to +47°	-47° to +47°
Mitre cut	-45° to +45°	-45° to +45°
Max. cutting capacity at 90°	305 x 85 mm	310 x 90 mm
Product weight	15.2 kg	15.7 kg
Saw blade tilting	left / right	left / right
Laser	•	•
Light	-	•
Soft start-up	-	•
X-Tend support with limit stop	-	•
Dust funnel	•	-
Quick-adjust facility for the saw table	•	-
Quick-adjust facility for the tilt of the saw head	•	-
Precision TCT saw blade	1 pc	1 pc
Article number	43.008.75	43.008.70



4 006825 635744



4 006825 599534

## SLIDING MITRE SAWS



	<b>TC-SM 2534/1 Dual</b> <b>CLASSIC</b>	<b>TC-SM 254</b> <b>CLASSIC</b>	<b>TC-SM 2531/2 U</b> <b>CLASSIC</b>
Mains connection	230 - 240 V ~ 50 Hz	220 - 240 V ~ 50 Hz	230 - 240 V ~ 50 Hz
Rated input	2350 W S6 25%	1900 W S6 25%	1900 W S1
Speed	4000 min <sup>-1</sup>	5000 min <sup>-1</sup>	4800 min <sup>-1</sup>
Saw blade	Ø 250 x Ø 30 mm	Ø 254 x Ø 30 mm	Ø 254 x Ø 30 mm
Number of teeth	48	48	48
Swivelling range	-47° to +47°	-47° to +47°	-45° to +45°
Mitre cut	-45° to +45°	0° to 45° to the left	0° to 45° to the left
Max. cutting capacity at 90°	340 x 75 mm	305 x 85 mm	310 x 70 mm
Product weight	14.3 kg	14.9 kg	17.8 kg
Saw blade tilting	left / right	left	left
Laser	•	•	•
Dust funnel	•	•	-
Quick-adjust facility for the saw table	-	•	-
Quick-adjust facility for the tilt of the saw head	-	-	-
Base frame	-	-	Working height 84 cm
Precision TCT saw blade	1 pc	1 pc	1 pc
Article number	43.003.95	43.003.85	43.008.05



4 006825 644890



4 006825 635713



4 006825 645637

## SLIDING MITRE SAWS



	<b>TE-SM 2131 Dual</b> <b>EXPERT</b>	<b>TE-SM 216 Dual</b> <b>EXPERT</b>
Mains connection	230 - 240 V ~ 50 Hz	220 - 240 V ~ 50 Hz
Rated input	1600 W S6 20%	1800 W S6 25%
Speed	5000 min <sup>-1</sup>	5000 min <sup>-1</sup>
Saw blade	Ø 210 x Ø 30 mm	Ø 216 x Ø 30 mm
Number of teeth	48	60
Swivelling range	-47° to +47°	-47° to +47°
Mitre cut	-45° to +45°	-45° to +45°
Max. cutting capacity at 90°	310 x 65 mm	305 x 65 mm
Product weight	12.5 kg	13.9 kg
Saw blade tilting	left / right	left / right
Laser	•	•
Light	•	-
Soft start-up	•	-
X-Tend support with limit stop	•	-
Dust funnel	-	•
Quick-adjust facility for the saw table	-	•
Quick-adjust facility for the tilt of the saw head	-	•
Precision TCT saw blade	1 pc	1 pc
Article number	43.008.60	43.008.65



4 006825 599527



4 006825 635737

## SLIDING MITRE SAWS



	<b>TC-SM 2131/1 Dual</b> <b>CLASSIC</b>	<b>TC-SM 216</b> <b>CLASSIC</b>
Mains connection	220 - 240 V ~ 50 Hz	220 - 240 V ~ 50 Hz
Rated input	1800 W S2 5 min	1600 W S6 25%
Speed	4900 min <sup>-1</sup>	5200 min <sup>-1</sup>
Saw blade	Ø 210 x Ø 30 mm	Ø 216 x Ø 30 mm
Number of teeth	48	48
Swivelling range	-47° to +47°	-47° to +47°
Mitre cut	-45° to +45°	0° to 45° to the left
Max. cutting capacity at 90°	310 x 62 mm	305 x 65 mm
Product weight	11.0 kg	12.7 kg
Saw blade tilting	left / right	left
Laser	•	•
Light	-	-
Soft start-up	-	-
X-Tend support with limit stop	-	-
Dust funnel	•	•
Quick-adjust facility for the saw table	-	•
Quick-adjust facility for the tilt of the saw head	-	•
Precision TCT saw blade	1 pc	1 pc
Article number	43.003.90	43.003.80



4 006825 644883



4 006825 635706

## MITRE SAWS



	<b>TC-MS 2513 L</b> <b>CLASSIC</b>	<b>TC-MS 2112</b> <b>CLASSIC</b>	<b>TC-MS 216</b> <b>CLASSIC</b>
Mains connection	230 - 240 V ~ 50 Hz	230 V ~ 50 Hz	220 - 240 V ~ 50 Hz
Rated input	1600 W S1	1600 W S6 40%	1600 W S6 25%
Speed	4000 min <sup>-1</sup>	5000 min <sup>-1</sup>	5000 min <sup>-1</sup>
Saw blade	Ø 250 x Ø 30 mm	Ø 210 x Ø 30 mm	Ø 216 x Ø 30 mm
Number of teeth	48	48	48
Swivelling range	-47° to +47°	-45° to +45°	-47° to +47°
Mitre cut	0° to 45° to the left	0° to 45° to the left	0° to 45° to the left
Max. cutting capacity at 90°	130 x 75 mm	120 x 55 mm	120 x 60 mm
Product weight	10.1 kg	7.1 kg	8.3 kg
Saw blade tilting	left	left	left
Laser	•	-	-
Dust funnel	-	-	•
Precision TCT saw blade	1 pc	1 pc	1 pc
Article number	43.008.50	43.002.95	43.003.70



4 006825 592122



4 006825 584929



4 006825 635683

## MITRE SAW WITH UPPER TABLE



	<b>TC-MS 3017 T</b> <b>CLASSIC</b>
Mains connection	230 - 240 V ~ 50 Hz
Rated input	2000 W S1
Speed	4200 min <sup>-1</sup>
Saw blade	Ø 305 x Ø 30 mm
Number of teeth	40
Swivelling range	-45° to +45°
Mitre cut	0° to 45° to the left
Max. cutting capacity at 90°	170 x 85 mm
Product weight	18.8 kg
Saw blade tilting	left
Laser	-
Dust funnel	-
Precision TCT saw blade	1 pc
Article number	43.003.47



4 006825 613056

**TABLE SAWS  
WITH BASE FRAME**

	<b>TE-CC 250 UF</b> <b>EXPERT</b>	<b>TE-TS 250 UF</b> <b>EXPERT</b>
Mains connection	220 - 240 V ~ 50 Hz	220 - 240 V ~ 50 Hz
Rated input	2000 W S6 20%	2000 W S6 20%
Speed	4500 min <sup>-1</sup>	4500 min <sup>-1</sup>
Saw blade	Ø 250 x Ø 30 mm	Ø 250 x Ø 30 mm
Number of teeth	48	48
Mitre cut	0° to 45° to the left	0° to 45° to the left
Cutting height 90°	78 mm	78 mm
Cutting height 45°	53 mm	53 mm
Bench size	645 x 530 mm	645 x 455 mm
Max. support surface	865 x 795 mm	775 x 675 mm
Product weight	34.9 kg	32.0 kg
Base frame	•	•
Table extension	right / rear	left / right / rear
Folding base frame	•	•
Format function	•	-
Soft start-up	•	•
Precision TCT saw blade	1 pc	1 pc
Parallel stop	•	•
Angle stop	•	•
Article number	43.405.39	43.405.68



4 006825 647518



4 006825 647501

**TABLE SAWS  
WITH BASE FRAME**

	<b>TC-TS 2225 U</b> <b>CLASSIC</b>	<b>TC-TS 254 U</b> <b>CLASSIC</b>
Mains connection	220 - 240 V ~ 50 Hz	220 - 240 V ~ 50 Hz
Rated input	2200 W S6 25%	2200 W S6 25%
Speed	4250 min <sup>-1</sup>	4250 min <sup>-1</sup>
Saw blade	Ø 254 x Ø 30 mm	Ø 254 x Ø 30 mm
Number of teeth	48	24
Mitre cut	0° to 45° to the left	0° to 45° to the left
Cutting height 90°	80 mm	80 mm
Cutting height 45°	55 mm	55 mm
Bench size	580 x 555 mm	580 x 555 mm
Max. support surface	780 x 1055 mm	580 x 855 mm
Product weight	26.2 kg	21.9 kg
Base frame	•	•
Table extension	left / right / rear	left / right
Folding base frame	-	-
Format function	-	-
Soft start-up	•	-
Precision TCT saw blade	1 pc	1 pc
Parallel stop	•	•
Angle stop	•	•
Article number	43.405.15	43.405.10



4 006825 641349



4 006825 646320

## TABLE SAWS WITH BASE FRAME



	TC-TS 2025/2 U <b>CLASSIC</b>	TC-TS 2025/3 eco <b>CLASSIC</b>	TC-TS 254 eco <b>CLASSIC</b>
Mains connection	220 - 240 V ~ 50 Hz	220 - 240 V ~ 50 Hz	220 - 240 V ~ 50 Hz
Rated input	2000 W S6 25%	2000 W S6 25%	2050 W S6 40%
Speed	5000 min <sup>-1</sup>	5000 min <sup>-1</sup>	4250 min <sup>-1</sup>
Saw blade	Ø 250 x Ø 30 mm	Ø 250 x Ø 30 mm	Ø 254 x Ø 30 mm
Number of teeth	24	24	24
Mitre cut	0° to 45° to the left	0° to 45° to the left	0° to 45° to the left
Cutting height 90°	85 mm	85 mm	80 mm
Cutting height 45°	65 mm	65 mm	55 mm
Bench size	583 x 563 mm	583 x 563 mm	580 x 555 mm
Max. support surface	583 x 893 mm	583 x 893 mm	580 x 555 mm
Product weight	19.2 kg	16.2 kg	18.6 kg
Base frame	•	•	•
Table extension	left / right	-	-
Folding base frame	-	-	-
Format function	-	-	-
Soft start-up	-	-	-
Precision TCT saw blade	1 pc	1 pc	1 pc
Parallel stop	•	•	•
Angle stop	•	•	•
Article number	43.404.90	43.404.95	43.405.05



4 006825 646474



4 006825 646481



4 006825 646337

## TABLE SAWS WITH BASE FRAME



	TE-TS 315 UD <b>EXPERT</b>	TE-TS 315 U <b>EXPERT</b>	TC-TS 315 U <b>CLASSIC</b>
Mains connection	400 V ~ 50 Hz	220 - 240 V ~ 50 Hz	220 - 240 V ~ 50 Hz
Rated input	2800 W S6 20%	2200 W S6 20%	2000 W S6 40%
Speed	2950 min <sup>-1</sup>	2950 min <sup>-1</sup>	2950 min <sup>-1</sup>
Saw blade	Ø 315 x Ø 30 mm	Ø 315 x Ø 30 mm	Ø 315 x Ø 30 mm
Number of teeth	24	24	40
Mitre cut	0° to 45° to the left	0° to 45° to the left	0° to 45° to the left
Cutting height 90°	85 mm	85 mm	85 mm
Cutting height 45°	55 mm	55 mm	55 mm
Bench size	800 x 550 mm	800 x 550 mm	800 x 550 mm
Table extension	740 x 460 mm	740 x 460 mm	740 x 400 mm
Product weight	52.0 kg	52.0 kg	52.6 kg
Base frame	•	•	•
Table extension	rear, folding	rear, folding	rear
Folding base frame	-	-	-
Format function	with optional slide	with optional slide	with optional slide
Soft start-up	-	-	-
Precision TCT saw blade	1 pc	1 pc	1 pc
Parallel stop	•	•	•
Angle stop	•	•	•
Article number	43.405.58	43.405.57	43.405.56



4 006825 646542



4 006825 646535



4 006825 640083

## TABLE SAWS



	TE-TS 254 T <b>EXPERT</b>	NEW
Mains connection	220 - 240 V ~ 50 Hz	
Rated input	2000 W S6 25%	
Speed	4700 min <sup>-1</sup>	
Saw blade	Ø 254 x Ø 30 mm	
Number of teeth	48	
Mitre cut	0° to 45° to the left	
Cutting height 90°	89 mm	
Cutting height 45°	63 mm	
Bench size	540 x 505 mm	
Max. support surface	540 x max. 975 mm	
Product weight	20.0 kg	
Soft start-up	•	
Precision TCT saw blade	1 pc	
Parallel stop	•	
Angle stop	•	
Article number	43.404.30	



4 006825 659160

## TABLE SAWS



	TC-TS 210 <b>CLASSIC</b>
Mains connection	220 - 240 V ~ 50 Hz
Rated input	1200 W S6 40%
Speed	4800 min <sup>-1</sup>
Saw blade	Ø 210 x Ø 30 mm
Number of teeth	24
Mitre cut	0° to 45° to the left
Cutting height 90°	45 mm
Cutting height 45°	27 mm
Bench size	525 x 440 mm
Max. support surface	525 x 440 mm
Product weight	11.3 kg
Precision TCT saw blade	1 pc
Parallel stop	•
Angle stop	•
Article number	43.404.25



4 006825 647273



	TC-TS 200 <b>CLASSIC</b>
Mains connection	230 - 240 V ~ 50 Hz
Rated input	800 W S6 15%
Speed	2950 min <sup>-1</sup>
Saw blade	Ø 200 x Ø 16 mm
Number of teeth	24
Mitre cut	0° to 45° to the left
Cutting height 90°	45 mm
Cutting height 45°	27 mm
Bench size	505 x 373 mm
Max. support surface	505 x 373 mm
Product weight	11.6 kg
Precision TCT saw blade	1 pc
Parallel stop	•
Angle stop	•
Article number	43.404.15



4 006825 647266

## STATIONARY PLANER



	TC-SP 204 <b>CLASSIC</b>
Mains connection	230 - 240 V ~ 50 Hz
Rated input	1500 W
Speed	9000 min <sup>-1</sup>
Max. working width	204 mm
Max. removal	3 mm
Max. thickness opening	120 mm
Max. angle of the parallel stop	45°
Dust extraction connector	100 mm
Product weight	27.2 kg
Infeed table	•
Removable table	•
Accessories	2 planing blades
Push stick	•
Article number	44.199.55



4 006825 615104

## SCROLL SAW



	TC-SS 405 E <b>CLASSIC</b>
Mains connection	230 V ~ 50 Hz
Rated input	120 W S2 10 min
Stroke speed	400 - 1600 min <sup>-1</sup>
Stroke height	14 mm
Reach	406 mm
Mitre cut	0° to 45° to the left
Cutting height 90°	52 mm
Cutting height 45°	20 mm
Product weight	12.5 kg
Workpiece hold-down device	•
Blowing function	•
Adapter for coping saw blade	•
Dust extraction	•
Saw blade	2 pcs
Article number	43.090.40



4 006825 589900



## BAND SAWS



	<b>TC-SB 305 U</b> <b>CLASSIC</b>	<b>TC-SB 245 L</b> <b>CLASSIC</b>	<b>TC-SB 200/1</b> <b>CLASSIC</b>
Mains connection	220 - 240 V ~ 50 Hz	220 - 240 V ~ 50 Hz	220 - 240 V ~ 50 Hz
Rated input	750 W	400 W	250 W S2 15 min
Blade speed	370 m/min   800 m/min	735 m/min	900 m/min
Reach	305 mm	245 mm	200 mm
Dust extraction connector	Ø 70 mm / Ø 100 mm	Ø 36 mm	Ø 36 mm
Mitre cut	0° to 45°	0° to 45°	-2° to 45°
Cutting height 90°	170 mm	101 mm	80 mm
Cutting height 45°	75 mm	60 mm	45 mm
Product weight	64.6 kg	24.8 kg	17.4 kg
Speed settings	2	1	1
Base frame	•	-	-
LED	-	•	-
Parallel stop	•	•	•
Angle stop	•	•	-
Article number	43.080.55	43.080.35	43.080.18



4 006825 608861



4 006825 649994



4 006825 617382



## WOODWORKING LATHE



	TC-WW 1000/1 <b>CLASSIC</b>
Mains connection	230 V ~ 50 Hz
Rated input	400 W S2 30 min
Speed 1	890 min <sup>-1</sup>
Speed 2	1260 min <sup>-1</sup>
Speed 3	1760 min <sup>-1</sup>
Speed 4	2600 min <sup>-1</sup>
Max. lathe diameter	280 mm
Tip width	1000 mm
Product weight	22.9 kg
V-belt drive which can be adjusted to 4 settings	•
Face plate	•
Tool support	•
Tailstock	•
Front end driver ring	•
Article number	43.121.10



## VACUUM EXTRACTION SYSTEM



	TE-VE 550/1 A <b>EXPERT</b>
Mains connection	220 - 240 V ~ 50-60 Hz
Rated input	550 W S1
Speed	2850 min <sup>-1</sup>
Debris bag volume	65 l
Air capacity	1150 m <sup>3</sup> /h
Vacuum	max. 1600 Pa
Hose length	2.5 m
Product weight	20.8 kg
Automatic socket	•
Handle	•
Chassis	•
Debris bag support	•
Quick release fastener for changing the debris bag	•
Induction motor	•
Catch basket	•
Multiadapter set	5-piece
Suction adapter	2x 36 mm to 100 mm
Article number	43.041.56



# WET AND DRY VACUUM CLEANERS

## HEAVY-DUTY HOSE

The 3.00 m suction hose is flexible and resistant to foot traffic at the same time

## PUSH BAR

Transport handle with trolley function for easy mobility. The cable holder keeps everything perfectly tidy

## AUTOMATIC DEVICE SOCKET

The automatic device socket with maximum 1900 W and synchronous start function makes it easier to work on ladders, for example

## STURDY STAINLESS STEEL TELESCOPIC TUBE

Intelligent plug-in connections reduce air turbulence and therefore increase the efficiency of the equipment

Wet and Dry Vacuum Cleaner  
**TE-VC 2340 SACL**

## WATER DRAIN SCREW

The water suctioned up can be discharged quickly and effortlessly

## DUST CLASS L

The vacuum cleaner for dust class L in accordance with Euro standards also filters extra-fine dust (e.g. plaster dust)



## SPEED CONTROLLER

The suction power is infinitely adjustable using the speed controller

## FILTER CLEANING SYSTEM

The integrated Filter Cleaning System ensures constant suction performance



## LARGE WHEELS AND CASTORS

Thanks to the 2 wheels and the 2 castors the wet and dry vacuum cleaner is easy to move about in the workshop, garage or living area

## ACCESSORY HOLDER

So the accessories are ready to hand and ready for action at all times

## WET AND DRY VACUUM CLEANERS

**INCL.**  
NUMEROUS  
ACCESSORIES



	<b>TE-VC 2350 SACL</b> <b>EXPERT</b>	<b>TE-VC 2340 SACL</b> <b>EXPERT</b>
Mains connection	220 - 240 V ~ 50/60 Hz	220 - 240 V ~ 50/60 Hz
Rated input	1600 W S1	1500 W S1
Suction power	230 mbar	225 mbar
Tank	Stainless steel, 50 l	Stainless steel, 40 l
Suction hose length / diameter	300 cm / 36 mm	300 cm / 36 mm
Cable length	600 cm	600 cm
Product weight	13.1 kg	10.1 kg
Cable holder	•	•
Blow connector	•	•
Accessory mount	•	•
Water drain screw	•	•
Automatic socket	•	•
ECO Power	•	•
Filter cleaning technology	•	•
Heavy-duty suction hose	•	•
Dust class L	•	•
Speed control	-	•
Suction tube	Telescopic, stainless steel	Telescopic, stainless steel
Nozzles	Combination, crevice and upholstery nozzle (1x each)	Combination, crevice and upholstery nozzle (1x each)
Filters	Foam & HEPA pleated filter, synthetic dust bag, dual dust bag (1x each)	Foam & HEPA pleated filter, synthetic dust bag (1x each)
Article number	23.424.75	23.424.70



4 006825 657494



4 006825 658347

## WET AND DRY VACUUM CLEANERS

**INCL.**  
NUMEROUS  
ACCESSORIES



	<b>TE-VC 2230 SACL</b> <b>EXPERT</b>	<b>TE-VC 2025 SACL</b> <b>EXPERT</b>
Mains connection	220 - 240 V ~ 50/60 Hz	220 - 240 V ~ 50/60 Hz
Rated input	1400 W S1	1200 W S1
Suction power	220 mbar	200 mbar
Tank	Stainless steel, 30 l	Stainless steel, 25 l
Suction hose length / diameter	300 cm / 36 mm	300 cm / 36 mm
Cable length	500 cm	500 cm
Product weight	9.2 kg	6.9 kg
Cable holder	•	•
Blow connector	•	•
Accessory mount	•	•
Water drain screw	•	•
Automatic socket	•	•
ECO Power	•	•
Filter cleaning technology	•	•
Heavy-duty suction hose	•	•
Dust class L	•	•
Speed control	•	•
Suction tube	Telescopic, stainless steel	Telescopic, stainless steel
Nozzles	Combination, crevice and upholstery nozzle (1x each)	Combination, crevice and upholstery nozzle (1x each)
Filters	Foam & HEPA pleated filter, synthetic dust bag (1x each)	Foam & HEPA pleated filter, synthetic dust bag (1x each)
Article number	23.424.65	23.424.60



4 006825 658330



4 006825 651799

## WET AND DRY VACUUM CLEANERS

**INCL.**  
NUMEROUS  
ACCESSORIES



	<b>TE-VC 2230 SA</b> <b>EXPERT</b>	<b>TC-VC 1930 SA Kit</b> <b>CLASSIC</b> <b>NEW</b>	<b>TC-VC 1930 SA</b> <b>CLASSIC</b>
Mains connection	230 V ~ 50 Hz	220 - 240 V ~ 50/60 Hz	220 - 240 V ~ 50/60 Hz
Rated input	1150 W S1	1500 W S1	1500 W S1
Suction power	220 mbar	190 mbar	190 mbar
Tank	Stainless steel, 30 l	Stainless steel, 30 l	Stainless steel, 30 l
Suction hose length / diameter	300 cm / 36 mm	250 cm / 36 mm	250 cm / 36 mm
Cable length	500 cm	300 cm	300 cm
Product weight	10.2 kg	5.3 kg	5.3 kg
Cable holder	•	•	•
Blow connector	•	•	•
Accessory mount	•	•	•
Water drain screw	•	•	•
Automatic socket	•	•	•
ECO Power	•	-	-
Suction tube	Telescopic, stainless steel	2-piece, plastic	2-piece, plastic
Nozzles	Combination, crevice and upholstery nozzle (1x each)	Combination, flat, crevice nozzle (short & long), upholstery, dirt brush	Combination, crevice nozzle (1x each)
Filters	Foam, pleated filter, dirt bag (1x each)	Foam filter, pleated filter (1x each)	Foam filter, pleated filter (1x each)
Article number	23.423.63	23.422.30	23.421.90



4 006825 586022



4 006825 659078



4 006825 584356

## WET AND DRY VACUUM CLEANERS

**INCL.**  
NUMEROUS  
ACCESSORIES



	<b>TE-VC 1925 SA</b> <b>EXPERT</b>	<b>TC-VC 1820 SA</b> <b>CLASSIC</b>
Mains connection	230 V ~ 50 Hz	220 - 240 V ~ 50/60 Hz
Rated input	800 W S1	1250 W S1
Suction power	190 mbar	180 mbar
Tank	Stainless steel, 25 l	Stainless steel, 20 l
Suction hose length / diameter	300 cm / 36 mm	150 cm / 36 mm
Cable length	500 cm	250 cm
Product weight	8.1 kg	4.0 kg
Cable holder	•	•
Blow connector	•	•
Accessory mount	•	•
Water drain screw	•	-
Automatic socket	•	•
ECO Power	•	-
Suction tube	Telescopic, stainless steel	3-piece, plastic
Nozzles	Combination, crevice and upholstery nozzle (1x each)	Combination, crevice nozzle (1x each)
Filters	Foam, pleated filter, dirt bag (1x each)	Foam filter, filter bag, dirt bag (1x each)
Article number	23.423.54	23.424.25



4 006825 586015



4 006825 629781

## WET AND DRY VACUUM CLEANERS

**INCL.**  
NUMEROUS  
ACCESSORIES



	<b>TC-VC 1930 S</b> <b>CLASSIC</b>	<b>TC-VC 1820 S</b> <b>CLASSIC</b>
Mains connection	220 - 240 V - 50/60 Hz	220 - 240 V - 50/60 Hz
Rated input	1500 W S1	1250 W S1
Suction power	190 mbar	180 mbar
Tank	Stainless steel, 30 l	Stainless steel, 20 l
Suction hose length / diameter	250 cm / 36 mm	150 cm / 36 mm
Cable length	300 cm	300 cm
Product weight	4.8 kg	3.5 kg
Cable holder	•	•
Blow connector	•	•
Accessory mount	•	•
Water drain screw	•	-
Automatic socket	-	-
ECO Power	-	-
Suction tube	2-piece, plastic	3-piece, plastic
Nozzles	Combination, crevice nozzle (1x each)	Combination, crevice nozzle (1x each)
Filters	Foam filter, pleated filter (1x each)	Foam filter, filter bag, dirt bag (1x each)
Article number	23.421.88	23.421.67



## WET AND DRY VACUUM CLEANERS

**INCL.**  
NUMEROUS  
ACCESSORIES



	<b>TC-VC 1815 S</b> <b>CLASSIC</b>	<b>TC-VC 1812 S</b> <b>CLASSIC</b>
Mains connection	220 - 240 V - 50 Hz	220 - 240 V - 50 Hz
Rated input	1250 W S1	1250 W S1
Suction power	180 mbar	180 mbar
Tank	Stainless steel, 15 l	Stainless steel, 12 l
Suction hose length / diameter	150 cm / 36 mm	150 cm / 36 mm
Cable length	250 cm	250 cm
Product weight	3.0 kg	2.9 kg
Cable holder	•	•
Blow connector	•	•
Accessory mount	•	•
Water drain screw	-	-
Automatic socket	-	-
ECO Power	-	-
Suction tube	3-piece, plastic	3-piece, plastic
Nozzles	Combination, crevice nozzle (1x each)	Combination, crevice nozzle (1x each)
Filters	Foam filter, filter bag, dirt bag (1x each)	Foam filter, filter bag, dirt bag (1x each)
Article number	23.423.90	23.423.70



## WET AND DRY VACUUM CLEANERS

**INCL.**  
NUMEROUS  
ACCESSORIES



	TC-VC 1825 <b>CLASSIC</b>	TC-VC 1815 <b>CLASSIC</b>
Mains connection	220 - 240 V ~ 50/60 Hz	220 - 240 V ~ 50/60 Hz
Rated input	1250 W S1	1250 W S1
Suction power	180 mbar	180 mbar
Tank	Plastic, 25 l	Plastic, 15 l
Suction hose length / diameter	250 cm / 36 mm	150 cm / 36 mm
Cable length	250 cm	250 cm
Product weight	4.3 kg	3.6 kg
Cable holder	•	•
Blow connector	•	•
Accessory mount	•	•
Water drain screw	-	-
Automatic socket	-	-
ECO Power	-	-
Suction tube	2-piece, plastic	3-piece, plastic
Nozzles	Combination, crevice nozzle (1x each)	Combination, crevice nozzle (1x each)
Filters	Foam, pleated filter, dirt bag (1x each)	Foam filter, filter bag, dirt bag (1x each)
Article number	23.424.30	23.402.90



## ASH VACUUM CLEANERS



	TC-AV 1720 DW <b>CLASSIC</b>	TC-AV 1718 D <b>CLASSIC</b>
Mains connection	220 - 240 V ~ 50/60 Hz	220 - 240 V ~ 50/60 Hz
Rated input	1250 W	1200 W
Suction power	175 mbar	170 mbar
Tank	Stainless steel, 20 l	Stainless steel, 18 l
Suction hose length / diameter	120 cm / 36 mm	100 cm / 36 mm
Cable length	200 cm	200 cm
Product weight	4.1 kg	3.5 kg
Carry handle	•	•
Castors	•	-
Pleated filter	•	•
Additional pre-filter	•	•
Article number	23.516.66	23.516.61



# HIGH PRESSURE CLEANERS

## QUICK COUPLE SYSTEM

Fast and flexible use of accessories thanks to the quick couple system

## WIND-UP REEL

The sturdy wind-up reel makes it possible to store the pressure hose conveniently while taking up little space

## STORAGE SPACE

Top marks for tidiness thanks to the generous storage space for accessories

## DETERGENT TANK

For fast and easy use of cleaning agents to remove the most stubborn dirt

## WATER FILTER

A filter is integrated in the water connection in order to protect the pump from damage

## PULL-OUT TELESCOPIC HANDLE

The telescopic handle can be ergonomically adjusted in height, enabling the appliance to be pulled and stowed away with ease

## WHEELS

The wheels guarantee both mobility and stability

High Pressure Cleaner  
**TE-HP 170**

## INCL. ACCESSORIES

The product is supplied complete with gun, pressure hose (10 m), lance with point and wide nozzle, rotating nozzle, brush and foam producer and patio-cleaner with tank





## HIGH PRESSURE CLEANERS



	TE-HP 170 <b>EXPERT</b> <span style="float: right;"><b>NEW</b></span>	TE-HP 140 <b>EXPERT</b> <span style="float: right;"><b>NEW</b></span>
Mains connection	220 - 240 V ~ 50 Hz	220 - 240 V ~ 50 Hz
Rated input	2300 W	1900 W
Max. working pressure	170 bar	140 bar
Delivery rate	440 l/h	420 l/h
Hose length	1000 cm	500 cm
Product weight	10.9 kg	10.8 kg
Carry handle	•	•
Storage options for the accessories	•	•
Telescopic handle	•	•
Wheels	•	•
Wind-up reel	•	•
Integrated detergent tank	•	•
Pinpoint and wide jet nozzle	Professional	Professional
Rotary cleaning head	Professional	Professional
Foam producer	Professional	Professional
Patio cleaner	Professional	Standard
Washing brush	Professional	Standard
Water connection with filter	•	•
Article number	41.407.70	41.407.60



4 006825 646429



4 006825 646412

## HIGH PRESSURE CLEANERS



	TC-HP 130 <b>CLASSIC</b> <span style="float: right;"><b>NEW</b></span>	TC-HP 90 <b>CLASSIC</b> <span style="float: right;"><b>NEW</b></span>
Mains connection	220 - 240 V ~ 50 Hz	220 - 240 V ~ 50 Hz
Rated input	1500 W	1200 W
Max. working pressure	130 bar	90 bar
Delivery rate	390 l/h	372 l/h
Hose length	500 cm	300 cm
Product weight	5.1 kg	4.9 kg
Carry handle	•	•
Storage options for the accessories	•	•
Telescopic handle	-	-
Wheels	•	-
Wind-up reel	-	-
Integrated detergent tank	-	-
Pinpoint and wide jet nozzle	Standard	Standard
Rotary cleaning head	Standard	-
Foam producer	Standard	-
Patio cleaner	-	-
Washing brush	Standard	-
Water connection with filter	•	•
Article number	41.407.50	41.407.40



4 006825 646399



4 006825 649857

# COMPRESSORS

## SILENT COMPRESSOR

Thanks to silent technology this compressor is much quieter than conventional compressors, without having to make any compromises in performance



## TANK

The 24 l tank provides ample air reserves for use with a whole range of air tools

## VERTICAL DESIGN

The compressor can be stored in a space-saving way thanks to its vertical design

Silent Air Compressor  
**TE-AC 24 Silent**

## PRESSURE GAUGE AND QUICK-RELEASE COUPLING

A pressure gauge and a quick-release coupling are available for controlled working pressure and a large pressure gauge is available for uncontrolled tank pressure



## 10 YEARS WARRANTY

The drain cock and the high quality provide the guarantee for a long service life – 10 years warranty against rusting through of the tank from the inside

## SAFE STANDING POSITION

Vibration-damped feet ensure that the product stands safely and firmly during operation

## SILENT AIR COMPRESSORS



	<b>TE-AC 50 Silent</b> <b>EXPERT PLUS</b>	<b>TE-AC 24 Silent</b> <b>EXPERT PLUS</b>
Mains connection	220 - 240 V ~ 50 Hz	220 - 240 V ~ 50 Hz
Power rating	1500 W S1	750 W S1
Suction power	270 l/min	135 l/min
Output rate 0 bar   4 bar   7 bar	190 l/min   120 l/min   90 l/min	100 l/min   73 l/min   55 l/min
Tank capacity	50 l	24 l
Max. operating pressure	8 bar	8 bar
Number of cylinders	4	2
Noise level (LpA)	54 dB(A)	57 dB(A)
Product weight	42.6 kg	22.2 kg
Silent technology	•	•
Oil-free pump	•	•
Pressure reducer	•	•
Article number	40.206.20	40.206.10



## SILENT AIR COMPRESSORS



	<b>TE-AC 6 Silent</b> <b>EXPERT PLUS</b>
Mains connection	220 - 240 V ~ 50 Hz
Power rating	550 W S1
Suction power	110 l/min
Output rate 0 bar   4 bar   7 bar	75 l/min   50 l/min   37 l/min
Tank capacity	6 l
Max. operating pressure	8 bar
Number of cylinders	2
Noise level (LpA)	57 dB(A)
Product weight	14.7 kg
Silent technology	•
Oil-free pump	•
Pressure reducer	•
Article number	40.206.00



## BELT-DRIVEN COMPRESSOR

**SUPER AIR**  
+ 25%  
POWER 10 bar



	<b>TE-AC 430/90/10</b> <b>EXPERT</b>
Mains connection	220 - 240 V ~ 50 Hz
Power rating	3000 W S1
Suction power	430 l/min
Output rate 0 bar   4 bar   7 bar	230 l/min   210 l/min   200 l/min
Tank capacity	90 l
Max. operating pressure	10 bar
Number of cylinders	2
Noise level	94 dB(A)
Product weight	68.4 kg
Double compressor unit	•
Belt drive	•
Pressure reducer	•
Article number	40.108.00



## OIL-LUBRICATED COMPRESSORS

**oil**  
LONG-LIFE  
MOTOR



	<b>TC-AC 420/50/10 V</b> <b>CLASSIC</b>	<b>TE-AC 270/50/10</b> <b>EXPERT</b>
Mains connection	220 - 240 V ~ 50 Hz	230 V ~ 50 Hz
Power rating	2200 W S1	1800 W S1
Suction power	420 l/min	270 l/min
Output rate 0 bar   4 bar   7 bar	245 l/min   200 l/min   150 l/min	140 l/min   127 l/min   100 l/min
Tank capacity	50 l	50 l
Max. operating pressure	10 bar	10 bar
Number of cylinders	2	1
Noise level	97 dB(A)	94 dB(A)
Product weight	41.8 kg	33.5 kg
Double compressor unit	•	-
Pressure reducer	•	•
Article number	40.104.95	40.104.40



## OIL-LUBRICATED COMPRESSORS



	<b>TE-AC 270/24/10</b> <b>EXPERT</b>	<b>TE-AC 230/24/8</b> <b>EXPERT</b>
Mains connection	230 V ~ 50 Hz	230 V ~ 50 Hz
Power rating	1800 W S1	1500 W S1
Suction power	270 l/min	230 l/min
Output rate 0 bar   4 bar   7 bar	140 l/min   127 l/min   100 l/min	132 l/min   102 l/min   83 l/min
Tank capacity	24 l	24 l
Max. operating pressure	10 bar	8 bar
Number of cylinders	1	1
Noise level	94 dB(A)	94 dB(A)
Product weight	27.0 kg	23.0 kg
Double compressor unit	-	-
Pressure reducer	•	•
Article number	40.104.50	40.104.60



4 006825 594461



4 006825 594478

## OIL-LUBRICATED COMPRESSORS



	<b>TC-AC 190/50/8</b> <b>CLASSIC</b>	<b>TC-AC 190/24/8</b> <b>CLASSIC</b>
Mains connection	220 - 240 V ~ 50 Hz	220 - 240 V ~ 50 Hz
Power rating	1500 W S2 15 min	1500 W S2 15 min
Suction power	165 l/min	165 l/min
Output rate 0 bar   4 bar   7 bar	110 l/min   75 l/min   55 l/min	110 l/min   75 l/min   55 l/min
Tank capacity	50 l	24 l
Max. operating pressure	8 bar	8 bar
Number of cylinders	1	1
Noise level	97 dB(A)	97 dB(A)
Product weight	26.3 kg	20.8 kg
Double compressor unit	-	-
Pressure reducer	•	•
Article number	40.073.32	40.073.25



4 006825 651720



4 006825 610635

## OIL-FREE COMPRESSORS



	<b>TC-AC 240/50/10 OF</b> <b>CLASSIC</b>	<b>TC-AC 200/24/8 OF</b> <b>CLASSIC</b>
Mains connection	230 V ~ 50 Hz	220 - 240 V ~ 50 Hz
Power rating	1500 W S3 25%	1200 W S1
Suction power	240 l/min	180 l/min
Output rate 0 bar   4 bar   7 bar	173 l/min   107 l/min   76 l/min	110 l/min   70 l/min   45 l/min
Tank capacity	50 l	24 l
Max. operating pressure	10 bar	8 bar
Number of cylinders	1	1
Noise level	97 dB(A)	97 dB(A)
Product weight	22.2 kg	16.0 kg
Cable storage	-	-
Oil-free pump	•	•
Accessory storage	•	-
Pressure reducer	•	•
Compressed air hose	-	-
Blow-out pistol	-	-
Tyre pressure gauge	-	-
Adapter set	-	-
Article number	40.103.93	40.205.90



## OIL-FREE COMPRESSORS



	<b>TC-AC 190/6/8 OF Set</b> <b>CLASSIC</b>	<b>TC-AC 190/6/8 OF</b> <b>CLASSIC</b>	<b>TC-AC 190 OF Set</b> <b>CLASSIC</b>
Mains connection	220 - 240 V ~ 50 Hz	230 V ~ 50 Hz	220 - 240 V ~ 50 Hz
Power rating	1200 W S1	1100 W S3 25%	1100 W S3 15%
Suction power	190 l/min	185 l/min	190 l/min
Output rate 0 bar   4 bar   7 bar	130 l/min   77 l/min   55 l/min	139 l/min   77 l/min   60 l/min	165 l/min   83 l/min   55 l/min without pressure chamber
Tank capacity	6 l	6 l	without pressure chamber
Max. operating pressure	8 bar	8 bar	8 bar
Number of cylinders	1	1	1
Noise level	97 dB(A)	97 dB(A)	97 dB(A)
Product weight	8.8 kg	9.1 kg	5.0 kg
Cable storage	•	•	•
Oil-free pump	•	•	•
Accessory storage	•	-	•
Pressure reducer	•	•	-
Compressed air hose	•	-	•
Blow-out pistol	•	-	•
Tyre pressure gauge	•	-	•
Adapter set	•	-	•
Article number	40.206.50	40.204.95	40.206.60



## AIR TOOLS



	<b>TC-PN 50</b> <b>CLASSIC</b>
Tool type	Stapler/nailed
Working pressure	max. 8.3 bar
Torque	-
Accessories	3x 500 staples, 2x 1000 nails
Packaging	Case
Article number	41.377.90



4 006825 641387



	<b>TC-PW 610 Compact</b> <b>CLASSIC</b> <b>NEW</b>	<b>TC-PW 610</b> <b>CLASSIC</b>	<b>TC-PW 340</b> <b>CLASSIC</b>
Tool type	Impact screwdriver	Impact screwdriver	Impact screwdriver
Working pressure	max. 8.0 bar	max. 6.3 bar	max. 6.3 bar
Torque	610 Nm	610 Nm	340 Nm
Accessories	3 plastic-sleeved drill sockets, 10 m thread seal tape	10 drill sockets, 1x extension	8 drill sockets
Packaging	Case	Case	Case
Article number	41.389.65	41.389.60	41.389.50



4 006825 660630



4 006825 639971



4 006825 639995



	<b>TC-PP 220</b> <b>CLASSIC</b>
Tool type	Pin grinder
Working pressure	max. 6.3 bar
Torque	-
Accessories	10 grinding stones
Packaging	Case
Article number	41.385.40



4 006825 641400

## AIR TOOLS



	<b>TC-PC 45</b> <b>CLASSIC</b>	<b>TC-PC 45 Set</b> <b>CLASSIC</b>
Tool type	Impact wrench	Impact wrench
Working pressure	max. 6.3 bar	max. 6.3 bar
Torque	-	-
Accessories	4-piece chisel set	4-piece chisel set, 1 needle scaler
Packaging	Case	Case
Article number	41.390.40	41.390.45



	<b>TC-PR 68</b> <b>CLASSIC</b>	<b>TC-PE 150</b> <b>CLASSIC</b>
Tool type	Ratchet screwdriver	Eccentric sander
Working pressure	max. 6.3 bar	max. 6.3 bar
Torque	68 Nm	-
Accessories	7 socket wrenches, 1 extension, 1 cardan joint	6 abrasive papers (2x P80, 2x P100, 2x P120)
Packaging	Case	Colour box
Article number	41.391.80	41.333.30



	<b>TC-PH 150</b> <b>CLASSIC</b> <span style="float: right;"><b>NEW</b></span>
Tool type	Automatic hose reel
Working pressure	max. 16 bar
Hose length	15 m
Length of connection hose	1.5 m
Hose inner diameter	9 mm
Packaging	Colour box
Article number	41.380.05





## AIR TOOLS



	Blow-out Pistol with 4 Nozzles <span style="float: right;">NEW</span>	Blow-out Pistol with 500 mm Nozzle <span style="float: right;">NEW</span>
Working pressure	2 - 8 bar	2 - 8 bar
Packaging	Colour box	Blister
Article number	41.327.62	41.327.63



	Blow-out Pistol, long	Blow-out Pistol, short	Blow-out Pistol Set
Working pressure	2 - 8 bar	2 - 8 bar	2 - 8 bar
Packaging	Colour box	Colour box	Colour box
Article number	41.331.02	41.331.00	41.327.59



	Tyre Pressure Gauge, digital	Pro Tyre Pressure Gauge	Tyre Pressure Gauge
Working pressure	0 - 13 bar	0 - 8 bar	0 - 8 bar
Packaging	Colour box	Colour box	Colour box
Article number	41.331.15	41.331.10	41.370.00



## AIR TOOLS



	Pro Paint Spray Gun	Paint Spray Gun	Paint Spray Gun
Technology	Cup	Cup	Suction-feed can
Tank volume	600 ml	600 ml	1000 ml
Working pressure	3 - 3.5 bar	3 - 4 bar	3 - 4 bar
Packaging	Colour box	Colour box	Colour box
Article number	41.330.30	41.330.00	41.329.00



	Spray Gun	Jet Gun	Suction Spray Gun	Underseal Gun
Technology	Suction-feed can	Suction-feed can	-	-
Tank volume	900 ml	1000 ml	-	-
Working pressure	3 - 8 bar	3 - 8 bar	0 - 7 bar	3 - 8 bar
Packaging	Colour box	Colour box	Colour box	Colour box
Article number	41.332.00	41.333.00	41.334.20	41.335.01



	Air Tool Set	Air Tool Set	Pro Compressed Air Set	Compressed Air Set
Items supplied	13-piece	10-piece	5-piece	3-piece
Packaging	Colour box	Colour box	Colour box	Colour box
Article number	41.327.76	40.205.77	41.327.20	41.327.41



**BENCH GRINDERS**

	<b>TC-BG 200 L</b> <b>CLASSIC</b>	<b>TC-BG 150</b> <b>CLASSIC</b>
Mains connection	220 - 240 V ~ 50 Hz	220 - 240 V ~ 50 Hz
Rated input	400 W S2 30 min	150 W S2 30 min
Speed	2980 min <sup>-1</sup>	2980 min <sup>-1</sup>
Grinding wheel diameter	200 mm	150 mm
Grinding wheel mount diameter	16 mm	12.7 mm
Wheel thickness	25 mm	16 mm
Grit size	36   60	36   60
Product weight	12.1 kg	6.0 kg
Adjustable speed	-	-
LED light	•	-
Toolless adjustable work support	•	•
Toolless adjustable spark guard windows	•	•
Flexible shaft	-	-
Accessories Set	-	-
Article number	44.126.33	44.126.32

**BENCH GRINDERS**

	<b>TC-XG 75 Kit</b> <b>CLASSIC</b>
Mains connection	220 - 240 V ~ 50 Hz
Rated input	150 W   5 min
Speed	adjustable up to 9900 min <sup>-1</sup>
Grinding wheel diameter	75 mm
Grinding wheel mount diameter	10 mm
Wheel thickness	20 mm
Grit size	120   400
Product weight	2.4 kg
Adjustable speed	•
LED light	-
Toolless adjustable work support	•
Toolless adjustable spark guard windows	•
Flexible shaft	•
Accessories Set	•
Article number	44.125.59



## WET GRINDER



TC-WG 200 <b>CLASSIC</b>	
Mains connection	220 - 240 V ~ 50 Hz
Rated input	125 W S1
Speed	110 min <sup>-1</sup>
Wet grinding wheel diameter	200 mm
Wet grinding wheel mount diameter	12.7 mm
Wet grinding wheel thickness	40 mm
Leather honing wheel Ø	180 mm
Leather honing wheel thickness	30 mm
Grain size (wet grinding wheel)	220
Product weight	8.2 kg
Slow-speed wet grinding wheel	•
Leather honing wheel	•
High-speed dry grinding wheel	-
Corrosion-resistant water tank	•
Carry handle	•
Universal support	•
Universal device for grinding a wide range of tools	•
Honing compound	•
Grinding stone	•
Angle gauge	•
Article number	44.180.08



## WET-DRY GRINDER



TC-WD 200/150 <b>CLASSIC</b>	
Mains connection	220 - 240 V ~ 50 Hz
Rated input	250 W S2 30 min
Speed	2980 min <sup>-1</sup>   134 min <sup>-1</sup>
Wheel diameter	150 mm   200 mm
Grinding wheel mount diameter	12.7 mm   20 mm
Wheel thickness	20 mm   40 mm
Grit size	36   200
Product weight	9.4 kg
Slow-speed wet grinding wheel	•
Leather honing wheel	-
High-speed dry grinding wheel	•
Corrosion-resistant water tank	•
Article number	44.172.42



## BELT-DISC SANDERS



	TC-US 380 <b>CLASSIC</b>	TC-US 350 <b>CLASSIC</b>
Mains connection	230 - 240 V ~ 50 Hz	220 - 240 V ~ 50 Hz
Rated input	380 W S6 20%	350 W S2 30 min
Grinding wheel speed	1500 min <sup>-1</sup>	2980 min <sup>-1</sup>
Belt speed	292 m/min	900 m/min
Grinding wheel	Ø 150 mm	Ø 150 x Ø 12.7 x 20 mm
Sanding/grinding belt	100 x 914 mm	50 x 686 mm
Swivelling range	-60° to 60°	-
Grit size	80   80	36   80
Product weight	11.5 kg	8.3 kg
Spark protection glass	-	•
Rubber feet for low vibration	•	•
Adjustable work support	•	•
Dust extraction	•	-
Tilting aluminium table	•	-
Cross stop	•	-
Sanding/grinding belt	•	•
Grinding/sanding wheel made of quality corundum	-	•
Grinding/sanding disc incl. grinding/sanding wheel	•	-
Article number	44.192.57	44.661.54



4 006825 649987



4 006825 649956

## METAL CUTTING SAWS



Illustration similar



	TC-MC 355/1 <b>CLASSIC</b>	<b>NEW</b>	TC-MC 355 <b>CLASSIC</b>
Mains connection	220 - 240 V ~ 50 Hz		220 - 240 V ~ 50 Hz
Rated input	2200 W		2300 W
Cutting wheel	Ø 355 x Ø 25.4 x 2.8 mm		Ø 355 x Ø 25.4 x 3.2 mm
Speed	3900 min <sup>-1</sup>		4000 min <sup>-1</sup>
Mitre cut	-15° to +45°		-15° to +45°
Max. saw width at 90°, rectangular profile	110 x 110 mm		100 x 100 mm
Max. saw width at 90°, round profile	Ø 125 mm		Ø 100 mm
Max. clamping range	230 mm		230 mm
Bench size	470 x 280 mm		460 x 260 mm
Product weight	15.0 kg		15.0 kg
Soft start-up	•		•
Height stop	•		•
Blade lock	•		•
Clamping mechanism with quick-release lock	•		•
Transport brace	•		•
Article number	45.031.39		45.031.35



4 006825 662719



4 006825 619966

# BENCH DRILLS

## VARIO-MATIC

The special gearing enables the speeds to be adjusted easily without elaborate conversion of the mechanical system

## LCD DISPLAY

The precise current speed is shown clearly in the display

## HIGH SAFETY STANDARDS

Maximum user safety is ensured by the Emergency Stop switch and the microswitch in the swivelable chip guard

## MK2 CHUCK

The MK2 mount enables even larger bits to be used

## QUICK-CHANGE DRILL CHUCK

The quality drill chuck enables the bits to be changed over quickly and holds 1 - 16 mm bits securely

## TABLE WITH WIDTH EXTENSION

The work table with allround coolant grooves can be adjusted to any position and has a pullout roll base for longer workpieces

## DEPTH STOP

Easy to adjust depth stop for exact (series) drilling

## INDUCTION MOTOR

Smooth-running, high-torque and long-lasting induction motor

## CAPSTAN

Large capstan with user-friendly handles for perfect power and feed control

## LED LIGHT

For illuminating the area to be drilled if needed, to make it easier to work with

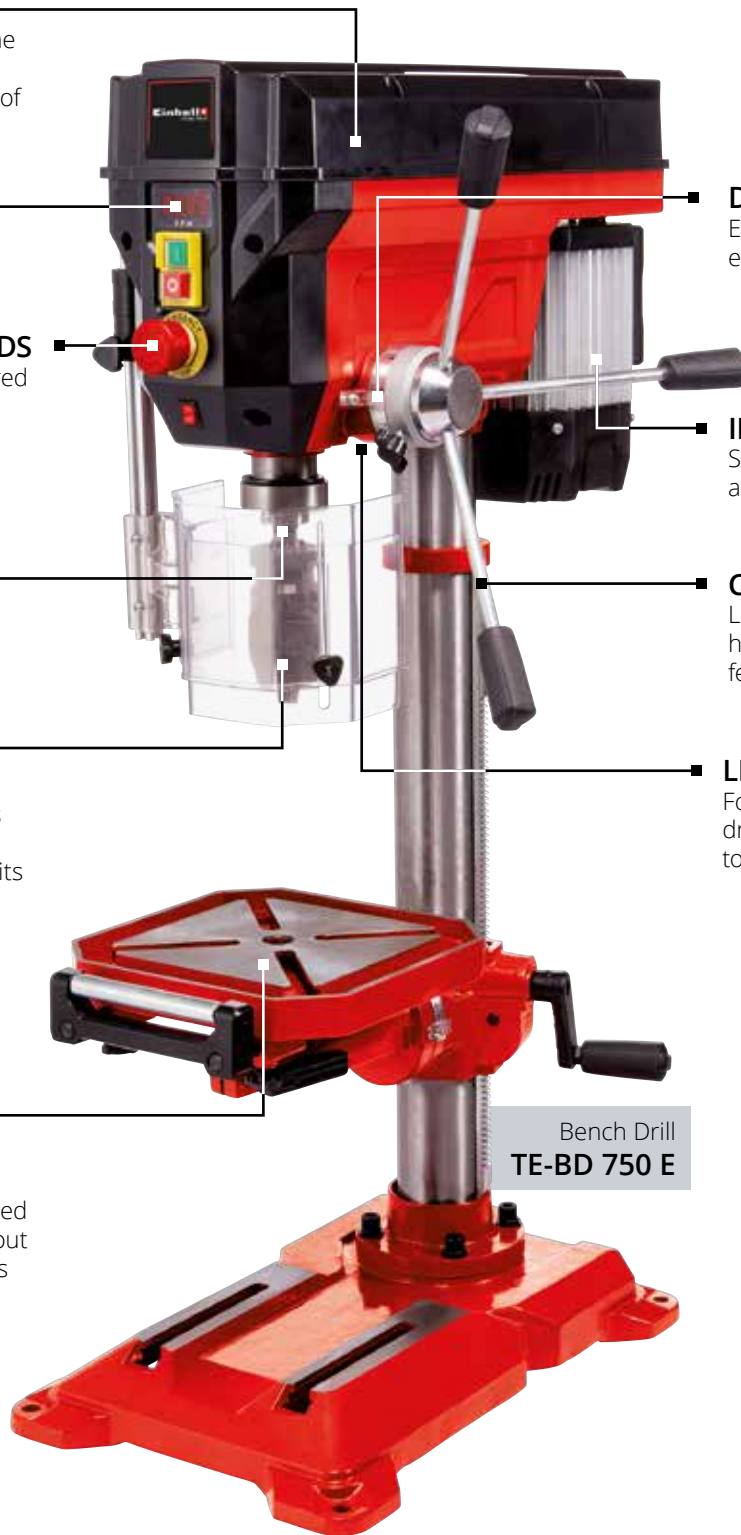

Bench Drill  
**TE-BD 750 E**

## BENCH DRILLS



	<b>TE-BD 750 E</b> <b>EXPERT</b>	<b>TE-BD 550 E</b> <b>EXPERT</b>	<b>TC-BD 630</b> <b>CLASSIC</b>
Mains connection	220 - 240 V ~ 50 Hz	230 - 240 V ~ 50 Hz	230 V ~ 50 Hz
Rated input	750 W S2 15 min	550 W S2 15 min	630 W S2 15 min
Speed	450 - 2500 min <sup>-1</sup>	450 - 2500 min <sup>-1</sup>	250 - 2450 min <sup>-1</sup>
Number of speed settings	Continuously	Continuously	12
Max. drilling depth	80 mm	60 mm	60 mm
Reach	152 mm	115 mm	126 mm
Drill diameter	1 - 16 mm	0 - 13 mm	1.5 - 16 mm
Drill table tiltable	-45° to +45°	-45° to +45°	-45° to +45°
Drill table size	243 x 243 mm	170 x 170 mm	200 x 195 mm
Base dimensions	304 x 456 mm	215 x 340 mm	230 x 350 mm
Machine height	955 mm	770 mm	850 mm
Product weight	44.4 kg	21.2 kg	32.6 kg
LED light	•	-	-
LCD speedometer	•	•	-
Quick-action chuck	•	•	-
Table extension	•	-	-
Drill chuck mount	B16	B16	B16
MK2 chuck	•	-	•
Machine vice	-	-	•
Article number	42.507.15	42.506.90	42.505.95



4 006825 617771



4 006825 634778



4 006825 633535

## BENCH DRILLS



	<b>TC-BD 500</b> <b>CLASSIC</b>	<b>TC-BD 450</b> <b>CLASSIC</b>	<b>TC-BD 350</b> <b>CLASSIC</b>
Mains connection	230 - 240 V ~ 50 Hz	230 - 240 V ~ 50 Hz	230 V ~ 50 Hz
Rated input	500 W S6 40%	450 W S6 20%	350 W S2 15 min
Speed	300 - 2410 min <sup>-1</sup>	600 - 2650 min <sup>-1</sup>	580 - 2650 min <sup>-1</sup>
Number of speed settings	9	5	5
Max. drilling depth	50 mm	50 mm	50 mm
Reach	115 mm	104 mm	104 mm
Drill diameter	1.5 - 13 mm	1.5 - 13 mm	1.5 - 13 mm
Drill table tiltable	-45° to +45°	-45° to +45°	-45° to +45°
Drill table size	170 x 170 mm	160 x 160 mm	160 x 160 mm
Base dimensions	200 x 315 mm	190 x 295 mm	185 x 290 mm
Machine height	630 mm	600 mm	590 mm
Product weight	15.0 kg	14.3 kg	13.9 kg
LED light	-	-	-
LCD speedometer	-	-	-
Quick-action chuck	-	-	-
Table extension	-	-	-
Drill chuck mount	B16	B16	B16
MK2 chuck	-	-	-
Machine vice	-	-	-
Article number	45.205.93	45.205.92	42.506.70



4 006825 649925



4 006825 649871



4 006825 627916

## STONE CUTTING MACHINES



	<b>TE-SC 920 L</b> <b>EXPERT</b>	<b>TE-SC 570 L</b> <b>EXPERT</b>
Mains connection	230 V ~ 50 Hz	230 V ~ 50 Hz
Rated input	2200 W S2 20 min	1500 W S2 20 min
Speed	3000 min <sup>-1</sup>	3000 min <sup>-1</sup>
Cutting height 90°   45°	70 mm   55 mm	60 mm   48 mm
Cutting length	920 mm	570 mm
Cutting wheel	Ø 300 x Ø 25.4 mm	Ø 250 x Ø 25.4 mm
Mitre cut	0° to 45° to the left	0° to 45° to the left
Product weight	53.5 kg	42.6 kg
Water bath container	•	•
Laser	•	•
Article number	43.014.32	43.014.44



4 006825 541199



4 006825 541243





## TILE CUTTING MACHINES



	<b>TE-TC 920 UL</b> <b>EXPERT</b>	<b>TE-TC 620 U</b> <b>EXPERT</b>
Mains connection	220 - 240 V ~ 50 Hz	230 V ~ 50 Hz
Rated input	900 W S2 30 min	900 W S2 30 min
Speed	2950 min <sup>-1</sup>	2950 min <sup>-1</sup>
Cutting height 90°   45°	36 mm   29 mm	30 mm   25 mm
Cutting length	920 mm	620 mm
Cutting wheel	Ø 200 x Ø 25.4 mm	Ø 200 x Ø 25.4 mm
Mitre cut	0° to 45° to the left	0° to 45° to the left
Product weight	42.7 kg	34.4 kg
Water bath container	•	•
Laser	•	-
Transport wheels	•	•
Parallel stop	•	•
Angle stop	•	•
Article number	43.012.20	43.012.95



## TILE CUTTING MACHINES



	<b>TC-TC 800</b> <b>CLASSIC</b>
Mains connection	220 - 240 V ~ 50 Hz
Rated input	800 W S2 10 min
Speed	2950 min <sup>-1</sup>
Cutting height 90°   45°	34 mm   14 mm
Cutting length	-
Cutting wheel	Ø 180 x Ø 25.4 mm
Mitre cut	0° to 45° to the left
Product weight	8.6 kg
Water bath container	•
Laser	-
Transport wheels	-
Parallel stop	•
Angle stop	•
Article number	43.011.85



## ELECTRIC HOISTS



	<b>TC-EH 1000</b> <b>CLASSIC</b>	<b>TC-EH 600</b> <b>CLASSIC</b>
Mains connection	220 - 240 V ~ 50 Hz	220 - 240 V ~ 50 Hz
Rated input	1600 W S3 25%	1050 W S3 20%
Lifting height without return pulley	18 m	18 m
Lifting height with return pulley	9 m	9 m
Payload without return pulley	500 kg	300 kg
Payload with return pulley	999 kg	600 kg
Hoisting speed without return pulley	8 m/min	8 m/min
Hoisting speed with return pulley	4 m/min	4 m/min
Product weight	32.0 kg	16.8 kg
Thermo switch	•	•
Automatic brake	•	•
Automatic limit cut-out	•	•
Twist-free wire cable	•	•
Operator switch with emergency stop function	•	•
Guide roller with load hook	•	•
Double clamps for mounting	•	•
Article number	22.551.60	22.551.50



## ELECTRIC HOISTS



	<b>TC-EH 500-18</b> <b>CLASSIC</b>	<b>TC-EH 500</b> <b>CLASSIC</b>
Mains connection	230 V ~ 50 Hz	230 V ~ 50 Hz
Rated input	1000 W S3 20%	800 W S3 20%
Lifting height without return pulley	18 m	11.5 m
Lifting height with return pulley	9 m	5.7 m
Payload without return pulley	250 kg	250 kg
Payload with return pulley	500 kg	500 kg
Hoisting speed without return pulley	8 m/min	8 m/min
Hoisting speed with return pulley	4 m/min	4 m/min
Product weight	16.1 kg	15.6 kg
Thermo switch	•	•
Automatic brake	•	•
Automatic limit cut-out	•	•
Twist-free wire cable	•	•
Operator switch with emergency stop function	•	•
Guide roller with load hook	•	•
Double clamps for mounting	•	•
Article number	22.551.45	22.551.40



## ELECTRIC HOISTS



	TC-EH 250-18 <b>CLASSIC</b>	TC-EH 250 <b>CLASSIC</b>
Mains connection	230 V ~ 50 Hz	230 V ~ 50 Hz
Rated input	500 W S3 20%	450 W S3 20%
Lifting height without return pulley	18 m	11.5 m
Lifting height with return pulley	9 m	5.7 m
Payload without return pulley	125 kg	125 kg
Payload with return pulley	250 kg	250 kg
Hoisting speed without return pulley	8 m/min	8 m/min
Hoisting speed with return pulley	4 m/min	4 m/min
Product weight	10.2 kg	10.0 kg
Thermo switch	•	•
Automatic brake	•	•
Automatic limit cut-out	•	•
Twist-free wire cable	•	•
Operator switch with emergency stop function	•	•
Guide roller with load hook	•	•
Double clamps for mounting	•	•
Article number	22.551.35	22.551.30



4 006825 633849



4 006825 627183

## CHAIN HOIST



## HOIST LEVER ARM



	TC-CH 1000 <b>CLASSIC</b>
Max payload	1000 kg
Max. lifting height	2.5 m
Product weight	8.5 kg
Load hook with safety catch	•
Closed metal housing	•
Article number	22.501.10



4 006825 628302

	SA 1100
Reach	75 - 110 cm
Maximum load at 75 cm	600 kg
Maximum load at 110 cm	300 kg
Swivelling range	180°
Product weight	8.3 kg
Article number	22.553.98



4 006825 540017

## HAND LEVER HOISTS



	TC-LW 2000 <b>CLASSIC</b>	TC-LW 1000 <b>CLASSIC</b>
Max. payload with guide roller	2000 kg	1000 kg
Pull cable length	3.3 m	2.2 m
Pull cable diameter	6.0 mm	4.8 mm
Max. effective distance	1.6 m	1.2 m
Product weight	5.2 kg	2.8 kg
Automatic brake	•	•
Load hook with safety catch	•	•
Safety clip	•	•
Twist-free wire cable	•	•
Reversing lock	•	•
Article number	22.601.50	22.601.40



4 006825 643244



4 006825 643237

## HAND ROPE WINCHES



	TC-WI 800 <b>CLASSIC</b>	TC-WI 500 <b>CLASSIC</b>
Max. tractive force	800 kg	500 kg
Pull cable length	20 m	10 m
Pull cable diameter	4.8 mm	4.2 mm
Product weight	4.7 kg	2.5 kg
Automatic brake	•	•
Load hook with safety catch	•	•
Safety clip	•	•
Twist-free wire cable	•	•
Reversing lock	•	•
Article number	22.601.70	22.601.60



4 006825 643916



4 006825 643909

## PALLET TRUCK



	<b>TC-PT 2500</b> <b>CLASSIC</b>
Max. load capacity	2500 kg
Fork height	80 mm - 190 mm
Diameter of load-bearing rollers	80 mm
Diameter of steering wheels	180 mm
Fork length	1150 mm
Fork width	540 mm
Product weight	62.0 kg
Safety handle with integral selector lever	•
Automatic return of the drawbar	•
Article number	20.225.30



## WORK BENCH



	<b>WB 50</b>
Max. load capacity	50 kg
Width	605 mm
Height	785 mm
Depth	235 - 350 mm
Folding	•
Accessories	4 plastic jaws
Article number	22.101.10



## TOOL AND GEAR WAGGONS



	<b>TC-TW 150</b> <b>CLASSIC</b>
Max. load capacity	150 kg
Width	685 mm
Height	875 mm
Depth	455 mm
Drawer 1	4x 50 mm
Drawer 2	2x 100 mm
Drawer 3	1x 205 mm
Product weight	52.5 kg
Article number	45.101.51



	<b>TC-TW 100</b> <b>CLASSIC</b>
Max. load capacity	75 kg
Width	616 mm
Height	658 mm
Depth	330 mm
Drawer 1	4x 70 mm
Drawer 2	1x 240 mm
Drawer 3	-
Product weight	18.7 kg
Article number	45.101.70



## INVERTER GENERATORS (PETROL)

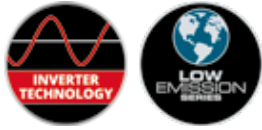

	TC-IG 2000 <b>CLASSIC</b>	TC-IG 1100 <b>CLASSIC</b>
Power rating at 400 V	-	-
Power rating at 230 V	2000 W S2 5 min   1800 W S1	1100 W S2 5 min   1000 W S1
Max. engine power	2400 W	1400 W
Speed	4500 min <sup>-1</sup>	3600 min <sup>-1</sup>
Engine displacement	105.6 cm <sup>3</sup>	79 cm <sup>3</sup>
Fuel tank capacity	4 l	6.5 l
Running time two-thirds load	5.3 h	5.4 h
Product weight	21.6 kg	20.9 kg
Tank with level indicator	-	•
Voltmeter	-	•
Inverter technology	•	•
Overload switch	•	•
Low oil stop	•	•
Electric start-up	-	-
Type of generator	Synchronous with inverter technology	Synchronous with inverter technology
Motor	Four-stroke, air cooled	Four-stroke, air cooled
Number of sockets	2x 230 V socket, 2x USB port	1x 230 V
Article number	41.525.90	41.525.80



4 006825 652413



4 006825 651089

## POWER GENERATORS (PETROL)



	TC-PG 65/E5 <b>CLASSIC</b>	<b>NEW</b>
Power rating at 400 V	6500 W (2 min) / 3600 W (S1)	
Power rating at 230 V	3400 W (5 min) / 3200 W (S1)	
Max. engine power	8000 W	
Speed	3000 min <sup>-1</sup>	
Engine displacement	420 cm <sup>3</sup>	
Fuel tank capacity	25 l	
Running time two-thirds load	11.7 h	
Product weight	83.3 kg	
Tank with level indicator	•	
Voltmeter	-	
Automatic voltage regulation (AVR)	•	
Overload switch	•	
Low oil stop	•	
Electric start-up	•	
Type of generator	Synchronous	
Motor	Four-stroke, air cooled	
Number of sockets	1x 12 V socket, 2x 230 V socket, 1x 400 V socket	
Article number	41.526.10	



4 006825 659993

## POWER GENERATORS (PETROL)



	<b>TC-PG 55/E5</b> <b>CLASSIC</b>	<b>TC-PG 35/E5</b> <b>CLASSIC</b>
Power rating at 400 V	5500 W (2 min)   3600 W (S1)	-
Power rating at 230 V	3300 W (2 min)   3000 W (S1)	3100 W (2 min)   2600 W (S1)
Max. engine power	7500 W	4100 W
Speed	3000 min <sup>-1</sup>	3000 min <sup>-1</sup>
Engine displacement	389 cm <sup>3</sup>	208 cm <sup>3</sup>
Fuel tank capacity	25 l	15 l
Running time two-thirds load	11.7 h	10.7 h
Product weight	82.8 kg	42.1 kg
Tank with level indicator	•	•
Voltmeter	-	•
Automatic voltage regulation (AVR)	•	•
Overload switch	•	•
Low oil stop	•	•
Electric start-up	•	-
Type of generator	Synchronous	Synchronous
Motor	Four-stroke, air cooled	Four-stroke, air cooled
Number of sockets	2x 230 V, 1x 400 V	2x 230 V
Article number	41.525.62	41.525.51



4 006825 644159



4 006825 644142

## POWER GENERATORS (PETROL)



	<b>TC-PG 25/1/E5</b> <b>CLASSIC</b>	<b>TC-PG 10/E5</b> <b>CLASSIC</b>
Power rating at 400 V	-	-
Power rating at 230 V	2400 W (2 min)   2100 W (S1)	800 W (1 min)   680 W (S1)
Max. engine power	4100 W	1000 W
Speed	3000 min <sup>-1</sup>	3000 min <sup>-1</sup>
Engine displacement	208 cm <sup>3</sup>	63.5 cm <sup>3</sup>
Fuel tank capacity	15 l	4 l
Running time two-thirds load	12.5 h	6.6 h
Product weight	38.8 kg	18.8 kg
Tank with level indicator	•	-
Voltmeter	•	-
Automatic voltage regulation (AVR)	•	•
Overload switch	•	•
Low oil stop	•	-
Electric start-up	-	-
Type of generator	Synchronous	Synchronous
Motor	Four-stroke, air cooled	Two-stroke, air cooled
Number of sockets	2x 230 V	1x 230 V
Article number	41.526.00	41.525.35



4 006825 657319



4 006825 648027

## ACCESSORIES – HANDHELD POWER TOOLS

### CORDLESS DRILLS ACCESSORIES



	Drills and Bits Set	Drills and Bits Set	Drills and Bits Set
Items supplied	24-piece	39-piece	39-piece
Screwdriver bits	•	•	•
Drill bits for metal	•	•	•
Wood drill bits	-	-	•
Masonry drill bits	-	-	•
Packaging	Storage case	Storage case	Storage case
Article number	49108806	49108911	49108956



### CORDLESS DRILLS ACCESSORIES



	Bits Set	Set of Drill Bit Cassettes
Items supplied	34-piece	15-piece: 3 drill bit cassettes with 5 bits in each
Screwdriver bits	•	-
Drill bits for metal	-	•
Wood drill bits	-	•
Masonry drill bits	-	•
Packaging	Storage case	Drill bit cassettes
Article number	49108801	49109157



### CORDLESS IMPACT DRIVERS ACCESSORIES



	Impact Bits Set
Items supplied	12-piece
Packaging	Patented bit box
Application	Specially for use with impact drivers
Set comprising	10 bits, bit holder, handle
Article number	49155025





**ROTARY HAMMERS  
ACCESSORIES**



	<b>SDS-plus Drill Bits/Chisels Set</b>	<b>SDS-plus Drill Bits Set</b>
Items supplied	10 hammer drill bits, 2 chisels	12 hammer drill bits
Drill chuck	SDS-plus	SDS-plus
Length	110 - 260 mm	110 - 260 mm
Drill bits Ø	5 - 16 mm	5 - 14 mm
Chisels	1x flat 20 mm, 1x pointed	-
Packaging	Plastic case	Plastic case
Article number	49240295	49240281



**ROTARY HAMMERS  
ACCESSORIES**

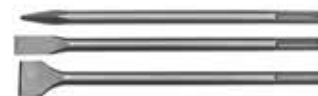

	<b>SDS-max Drill Bits/Chisels Set</b>	<b>SDS-max Drill Bits Set</b>
Items supplied	3 hammer drill bits, 2 chisels	3 chisels
Drill chuck	SDS-max	SDS-max
Length	400 mm	400 mm
Drill bits Ø	18, 20, 25 mm	-
Chisels	1x flat 25 mm, 1x pointed	2x flat (25 / 40 mm), 1x pointed
Packaging	Plastic case	Storage tube
Article number	49194005	49190103



**ROTARY HAMMERS  
ACCESSORIES**



	<b>Flat Chisel 40 x 410 mm Hex</b>	<b>Pointed Chisel 410 mm Hex</b>
Items supplied	1 chisel	1 chisel
Drill chuck	SDS-hex	SDS-hex
Length	410 mm	410 mm
Width	40 mm	-
Article number	49191045	49191145



**PAINT/MORTAR MIXERS ACCESSORIES**

Type	Article number	EAN	Items supplied	Ø	Length	Stirrer mount
Lacquer Mixer	49497005	4 009314 970050	1 pc	80 mm	400 mm	Hex
Paint Mixer	49497215	4 009314 972153	1 pc	100 mm	600 mm	Hex
Mortar Mixer	49497615	4 009314 976151	1 pc	90 mm	600 mm	Hex
Mortar Mixer M14	49497625	4 009314 976250	1 pc	90 mm	600 mm	M14
Paint Mixer M14	49497635	4 009314 976359	1 pc	120 mm	600 mm	M14
Mixer Set M14	49497695	4 009314 976953	2 pcs	135 mm (paint mixer) / 120 mm (mortar mixer)	585 mm (paint mixer) / 585 mm (mortar mixer)	M14
Twin Mixer Mortar	49497795	4 009314 977950	1 pc	120 mm	550 mm	Hex

**ANGLE GRINDERS ACCESSORIES**

Type	Article number	EAN	Items supplied	Ø	Ø hole	Grit size	Number of strips	Can be used for
Sanding Mops/ Sanding Plates Set	49795505	4 009317 955054	2-piece	115 mm	22 mm	40 grit, 80 grit - 1 of each	62 each	Metalworking and woodworking
Sanding Mops/ Sanding Plates Set	49795705	4 009317 957058	2-piece	125 mm	22 mm	40 grit, 80 grit - 1 of each	62 each	Metalworking and woodworking
Sanding Mops/ Sanding Plates Set	49795805	4 009317 958055	2-piece	150 mm	22 mm	40 grit, 80 grit - 1 of each	76 each	Metalworking and woodworking

**ANGLE GRINDERS ACCESSORIES**

Type	Article number	EAN	Items supplied	Ø	Ø hole	Thickness	Can be used for
Diamond Cutting Wheels Set	49797605	4 009317 976059	1 turbo, 1 segmented cutting wheel	230 mm	22 mm	2.6 mm / 3.3 mm	Bricks, concrete blocks, engineering bricks, tiles
Thin Cutting Wheels Set	49711949	4 009317 119494	1 pc	150 mm	22 mm	1.6 mm	Metal and stainless steel
Thin Cutting Wheels Set	49711946	4 009317 119463	5 pcs	150 mm	22 mm	1.4 mm	Metal and stainless steel
Diamond Thin Cutting Wheel	49721550	4 009317 215509	1 pc	150 mm	22 mm	1.6 mm	Stone, concrete, tiles, ceramic, fired stoneware, marble, granite
Thin Cutting Wheels Set	49711945	4 009317 119456	10 pcs	125 mm	22 mm	1.0 mm	Metal and stainless steel
Diamond Thin Cutting Wheel	49724550	4 009317 245506	1 pc	125 mm	22 mm	1.2 mm	Stone, concrete, tiles, ceramic, fired stoneware, marble, granite
Thin Cutting Wheels Set	49711944	4 009317 119449	10 pcs	115 mm	22 mm	1.0 mm	Metal and stainless steel
Diamond Thin Cutting Wheel	49721150	4 009317 211501	1 pc	115 mm	22 mm	1.2 mm	Stone, concrete, tiles, ceramic, fired stoneware, marble, granite



### ANGLE GRINDERS ACCESSORIES

	Type	Article number	EAN	Mount	Packaging
	Quick Fix Nut	49717705	4 009317 177050	M14	Colour box

### ANGLE GRINDERS ACCESSORIES

	Type	Article number	EAN	For angle grinders with wheels Ø	Packaging
	TS 115/125 Cutting Stand	44.310.44	4 006825 632736	115 / 125 mm	Colour box
	TS 230/1 Cutting Stand	44.310.51	4 006825 632743	230 mm	Colour box

### BISCUIT JOINTERS ACCESSORIES



	Type	Article number	EAN	Ø	Ø hole	Cutting width	Number of teeth
	TCT Cutter Blade	49758941	4 009317 589419	100 mm	22 mm	3.8 mm	6

### ROUTERS ACCESSORIES

	Type	Article number	EAN	Items supplied	Packaging
	Gang Cutter Set	49757291	4 009317 572916	15-piece	Wooden case

### PLANERS ACCESSORIES

	Type	Article number	EAN	Items supplied	Length	Material	Packaging
	Blade Set	49568315	4 009315 683157	2 reversible blades	82 mm	Hard metal	Colour box

JIGSAWS ACCESSORIES					
	Type	Article number	EAN	Items supplied	Packaging
	Jigsaw Blades Set	49617350	4 009316 173503	10 saw blades: 6x saw blades for hardwood and softwood (fine, medium, rough - 2 of each), 2x saw blades wood down cut for laminate/wooden boards/plastics, 2x saw blades for metal/aluminium/plastics/wood with metal remains	Plastic cassette
	Jigsaw Blades Set 4-piece Akku-Top	49625427	4 009316 254271	2x saw blades wood down cut for laminate/wooden boards/plastics, 1x saw blade for softwood and hardwood, 1x saw blade for metal/aluminium/plastics/wood with metal remains	Blister card

CIRCULAR SAWS ACCESSORIES								
	Type	Article number	EAN	Ø	Cutting width / blade thickness	Ø hole	Number of teeth	Type of saw blade
	TCT Saw Blade for Woodworking	49583359	4 009315 833590	150 mm	1.6 mm / 1.0 mm	Ø 16 mm	20	carbide tipped
	TCT Saw Blade for Woodworking	49584759	4 009315 847597	165 mm	1.6 mm / 1.0 mm	Ø 20 mm	24	carbide tipped
	TCT Saw Blade for Woodworking	49586956	4 009315 869568	190 mm	2.0 mm / 1.4 mm	Ø 30 mm	30	carbide tipped

CIRCULAR SAWS ACCESSORIES								
	Type	Article number	EAN	Can be used for	Set	Length (total)	Packaging	
	Guide Bar Aluminium 2x 1000 mm	45.021.18	4 006825 632675	TE-PS 165   TC-CS 1250   TC-CS 1410   TE-CS 165   TE-CS 190/1   TE-CS 18/150 Li   TE-CS 18/165-1 Li   TP-CS 18/190 Li BL	2-piece	2000 mm	Colour box	

MINI CIRCULAR SAWS ACCESSORIES							
	Type	Article number	EAN	Ø	Ø hole	Number of teeth	Rim shape diamond cutting wheel
	Saw Blades Set	49575915	4 009315 759159	89 mm	10 mm	74 (HSS) / 36 (TCT)	Continuous rim

ALL PURPOSE SAWS ACCESSORIES				
	Type	Article number	EAN	Set comprising
	All Purpose Saw Blades Set 3-piece Akku-Top	49576105	4 009315 761053	Saw blades (1 of each) for wood (fine cut), wood (rough cut), metal/plastics/wood with metal remains/bi-metal

### MULTIFUNCTIONAL TOOLS ACCESSORIES



	Starter Kit	Floor Installation Kit	Tile Kit
Items supplied	17-piece	4-piece	4-piece
Scraper	-	•	-
Plunge-cut blades	2x wood/plastic, 1x metal	2x wood/plastic	-
Segment saw blades	1x wood/metal/plastic	1x wood/metal/plastic	1x tile joints/lime sand brick/aerated concrete
Grater	-	-	1x mortar / tile adhesive / carpet scraps
Hook-and-loop disc	1x 93 mm	-	-
Abrasive paper (wood, metal, plastic)	40 grit, 80 grit, 120 grit - 4 of each	-	-
Silicone joint scraper	-	-	1x 28 x 50 mm
Silicone joint smoothing trowel	-	-	for narrow and wide silicone joints
Article number	49708950	49708850	49708750



4 009317 089506



4 009317 088509



4 009317 087502

### GRINDING AND ENGRAVING TOOLS ACCESSORIES

	Type	Article number	EAN	Items supplied	Can be used for	Packaging
	Accessories Set	49510950	4 009315 109503	61-piece	Grinding/engraving tools	Storage case
	Accessories Set	49510951	4 009315 109510	38-piece	Grinding/engraving tools and bench grinders	Storage case

### ORBITAL SANDERS ACCESSORIES

	Type	Article number	EAN	Abrasive paper size	Items supplied	Grit size	With holes	Can be used for
	Abrasive Paper Set	49817985	4 009318 179855	187 x 93 mm	15 pcs	60 / 120 / 180 grit (5 of each)	•	Wood and metal
	Abrasive Paper Set	49818975	4 009318 189755	230 x 115 mm	15 pcs	40 / 80 / 120 grit (5 of each)	•	Wood and metal

### BAND SANDERS ACCESSORIES

	Type	Article number	EAN	Abrasive paper size	Items supplied	Grit size	Can be used for
	Grinding Belt Set	49912575	4 009319 125752	75 x 533 mm	5 pcs	2x 40 grit, 2x 80 grit, 1x 120 grit	Wood and metal

**DELTA SANDERS ACCESSORIES**

	Type	Article number	EAN	Abrasive paper size	Items supplied	Grit size	With holes	Can be used for
	Abrasive Paper Set	49492874	4 009314 928747	93 x 93 x 93 mm	20 pcs	8x 60 grit, 6x 120 grit, 6x 180 grit	•	Wood and metal

**MULTI SANDERS ACCESSORIES**

	Type	Article number	EAN	Abrasive paper size	Items supplied	Grit size	With holes	Can be used for
	Abrasive Paper Set	49496174	4 009314 961744	150 x 150 x 150 mm	15 pcs	60 / 120 / 180 grit (5 of each)	•	Wood and metal



**ROTATING SANDERS ACCESSORIES**

	Type	Article number	EAN	Abrasive paper size	Items supplied	Grit size	With holes	Can be used for
	Abrasive Paper Set	49491974	4 009314 919745	125 mm	25 pcs	9x 60 grit, 8x 120 grit, 8x 180 grit	•	Wood and metal

**WALL AND CONCRETE GRINDERS ACCESSORIES**

	Type	Article number	EAN	Items supplied	∅	Abrasive mesh, universal	Corundum grinding/sanding wheel, white	Corundum grinding/sanding wheel, red
	Abrasive Mesh / Grinding/Sanding Wheel Set	49490905	4 009314 909050	5-piece	180 mm	3x 80 grit, 2x 120 grit for filling compound/paint/acrylic lacquer/synthetic resin/rust	–	–
	Abrasive Set	49490965	4 009314 909654	15-piece	180 mm	4x 80 grit, 2x 120 grit for filling compound/acrylic lacquer	4x 80 grit, 2x 120 grit for lacquer/hardwood/softwood	2x 80 grit, 1x 120 grit for wood/metal/plastics



**WALL AND CONCRETE GRINDERS ACCESSORIES**

	Type	Article number	EAN	Items supplied	Application	∅	Segment height
	Grinding Brush	49490985	4 009314 909852	1 pc	Derusting and cleaning metal and wood	180 mm	–
	Diamond Sanding Plate	49726855	4 009317 268550	1 pc	Cleaning concrete, screed, mortar, natural stone	180 mm	6 mm



**DRYWALL POLISHERS ACCESSORIES**

	Type	Article number	EAN	Items supplied	Ø	Abrasive mesh, universal	Corundum grinding/sanding wheel, white	Corundum grinding/sanding wheel, red
	Abrasive Mesh / Grinding/Sanding Wheel Set	49491006	4 009314 910063	5-piece	225 mm	3x 80 grit, 2x 120 grit	–	–
	Abrasive Paper Set	49491066	4 009314 910667	15-piece	225 mm	4x 80 grit, 2x 120 grit for filling compound/acrylic lacquer	4x 80 grit, 2x 120 grit for lacquer/hardwood/softwood	2x 80 grit, 1x 120 grit for wood/metal/plastics

**DRYWALL POLISHERS ACCESSORIES**

	Type	Article number	EAN	Items supplied	Set comprising
	Abrasive Mesh / Grinding/Sanding Wheel Set	49491005	4 009314 910056	5-piece	3x abrasive mesh, universal, Ø 225 mm (2x 80 grit, 1x 120 grit) for filling compound/acrylic lacquer, 2x delta abrasive mesh 287 x 287 x 287 mm (2x 80 grit)
	Abrasive Set	49491065	4 009314 910650	15-piece	4x abrasive mesh, universal, Ø 225 mm (3x 80 grit, 1x 120 grit) for filling compound/acrylic lacquer, 2x delta abrasive mesh, 287 x 287 x 287 mm (2x 80 grit), 5x grinding/sanding wheels, Ø 225 (4x 80 grit, 1x 120 grit), 2x delta abrasive paper, 287 x 287 x 287 mm (80 grit) for lacquer/plastics, 1x corundum grinding/sanding wheel, red, Ø 225 mm (80 grit), 1x corundum delta abrasive paper, red, 287 x 287 x 287 mm (80 grit)
	Delta Abrasive Papers Set	49491075	4 009314 910759	5-piece	2x delta abrasive mesh, 287 x 287 x 287 mm (2x 80 grit), 2x delta abrasive paper, 287 x 287 x 287 mm (80 grit), 1x corundum delta abrasive paper, red, 287 x 287 x 287 mm (80 grit)

**CORDLESS POLISHING/SANDING MACHINES ACCESSORIES**

	Type	Article number	EAN	Can be used for	Set comprising
	Polishing Bonnets Set	20.930.95	4 006825 631517	CE-CB 18/254 Li	1 textile bonnet, 1 synthetic bonnet
	Polishing/Grinding Set 180 mm	20.932.33	4 006825 551846	CE-CP 18/180 Li E	2x synthetic bonnet, 1x foam pad, 6x abrasive paper (60 / 80 / 120 grit, 2 of each)
	Polishing/Grinding Set 150 mm (incl. plate)	20.932.45	4 006825 653977	CE-CP 18/180 Li E	1x sanding plate 150 mm, 2x synthetic bonnet, 1x foam pad, 6x abrasive paper (60 / 80 / 120 grit, 2 of each)



**ELECTRIC PAINT SPRAY SYSTEMS ACCESSORIES**

	Type	Article number	EAN	Filling quantity	Packaging
	Paint Spray Attachment	42.600.03	4 006825 619515	800 ml	Colour box
	Paint Tub	42.600.02	4 006825 619508	1000 ml	Colour box
	Paint Tub	42.600.01	4 006825 619492	800 ml	Colour box



**HOT AIR GUNS ACCESSORIES**

	Type	Article number	EAN	∅	Length	Quantity
	Glue Sticks	49538955	4 009315 389554	7 mm	150 mm	24 pcs
	Glue Sticks	49539355	4 009315 393551	11 mm	200 mm	24 pcs

**TACKERS ACCESSORIES**

	Type	Article number	EAN	Type	Length	Width	Quantity	Suitable for
	Staples	49353508	4 009313 535083	53	8 mm	11.4 mm	1000 pcs	TC-CT 3.6 Li / TC-EN 20 E
	Nails	49355614	4 009313 556149	47 / 55	14 mm	1.8 mm	1000 pcs	TC-CT 3.6 Li / TC-EN 20 E

**POWER X-CHANGE TACKERS ACCESSORIES**

	Type	Article number	EAN	Type	Length	Width	Quantity	Suitable for
	Staples	41.378.75	4 006825 658385	E	19 mm	5.7 mm	3000 pcs	TE-CN 18 Li
	Nails	41.378.74	4 006825 658378	J	32 mm	1.0 mm	3000 pcs	TE-CN 18 Li

**LASER TECHNOLOGY ACCESSORIES**

	Type	Article number	EAN	Working height	Tilt angle adjustment	Storage case	Product weight	Packaging
	Tripod	22.701.15	4 006825 616255	37 - 110 cm	•	•	0.5 kg	Colour box



## ACCESSORIES – STATIONARY POWER TOOLS

### MITRE SAWS ACCESSORIES



	E-Stand
Mounting width	340 - 445 mm
Mounting depth	max. 410 mm
Table height	81 cm
Article number	43.106.20



4 006825 584974

### MITRE SAWS ACCESSORIES



	MSS 1610	MSS 1608
Total length	1100 - 1610 mm	1090 - 1620 mm
Load capacity	max. 100 kg	max. 75 kg
Working height	845 - 945 mm	755 mm
Load-bearing length of machine support	max. 455 mm	max. 375 mm
User-friendly adjustment facilities	•	-
Workpiece trays	•	•
Height-adjustable foot	•	-
Storage boxes	•	-
Folding	•	•
Carry handle	•	-
Machine supports	1 pair	1 pair
Article number	43.106.15	43.106.14



4 006825 637496



4 006825 660050

### STATIONARY SAWS ACCESSORIES – SLIDING TABLE









	ST 315
Angular adjustment	0° - 55°
Suitable for	TC-TS 315 U, TE-TS 315 U, TE-TS 315 UD
Article number	43.405.59



4 006825 648744

**MITRE SAWS AND TABLE SAWS ACCESSORIES**

	Type	Article number	EAN	Ø	Ø hole	Cutting width / blade thickness	Number of teeth	Type of saw blade	Storage
	TCT Saw Blade	49587151	4 009315 871516	200 mm	16 mm	2.4 mm / 1.6 mm	20	carbide tipped	–
	TCT Thin Cutting Saw Blade	49587852	4 009315 878522	210 mm	30 mm	1.8 mm / 1.2 mm	40	carbide tipped	–
	TCT Saw Blade	49587861	4 009315 878614	210 mm	30 mm	2.4 mm / 1.6 mm	48	carbide tipped	–
	TCT Thin Cutting Saw Blade	49587862	4 009315 878621	210 mm	30 mm	1.8 mm / 1.2 mm	64	carbide tipped	–
	TCT Saw Blade Set, 3-piece	49587805	4 009315 878058	210 mm	30 mm	2.5 mm / 1.6 mm	24 / 42 / 60	carbide tipped	Plastic tray
	TCT Saw Blade	49588261	4 009315 882611	216 mm	30 mm	2.4 mm / 1.6 mm	60	carbide tipped	–
	TCT Saw Blade	49588251	4 009315 882512	216 mm	30 mm	2.4 mm / 1.6 mm	48	carbide tipped	–
	TCT Saw Blade Set, 3-piece	49587806	4 006825 661996	216 mm	30 mm	2.4 mm / 1.6 mm	24 / 42 / 60	carbide tipped	Plastic tray
	TCT Thin Cutting Saw Blade	49589352	4 009315 893525	250 mm	30 mm	1.8 mm / 1.2 mm	42	carbide tipped	–
	TCT Saw Blade	49589341	4 009315 893419	250 mm	30 mm	3.2 mm / 2.2 mm	24	carbide tipped	–
	TCT Saw Blade	49589351	4 009315 893518	250 mm	30 mm	3.2 mm / 2.2 mm	48	carbide tipped	–
	TCT Saw Blade	49589552	4 009315 895529	250 mm	30 mm	3.2 mm / 2.2 mm	60	carbide tipped	–
	TCT Saw Blade Set, 2-piece	49589305	4 009315 893051	250 mm	30 mm	3.2 mm / 2.2 mm	24 / 60	carbide tipped	Plastic tray
	TCT Saw Blade Set, 3-piece	49589306	4 009315 893068	250 mm	30 mm	3.2 mm / 2.2 mm	24 / 42 / 60	carbide tipped	Plastic tray
	TCT Thin Cutting Saw Blade	49589361	4 009315 893617	254 mm	30 mm	1.8 mm / 1.2 mm	42	carbide tipped	–
	TCT Saw Blade	49589551	4 009315 895512	254 mm	30 mm	3.2 mm / 2.2 mm	48	carbide tipped	–
	TCT Saw Blade	49589561	4 009315 895611	254 mm	30 mm	3.2 mm / 2.2 mm	60	carbide tipped	–
	TCT Saw Blade Set, 3-piece	49589307	4 006825 662009	254 mm	30 mm	3.2 mm / 2.2 mm	24 / 42 / 60	carbide tipped	Plastic tray
	TCT Saw Blade	49592957	4 009315 929576	305 mm	30 mm	3.0 mm / 2.2 mm	40	carbide tipped	–
	TCT Saw Blade	49593151	4 009315 931517	315 mm	30 mm	3.2 mm / 2.2 mm	48	carbide tipped	–

## ASSIGNMENT OF ACCESSORIES TO STATIONARY SAWS

			Sliding Mitre Saws						Mitre Saws				Table Saws																	
			TE-SM 36/210 Li - Solo	TE-MS 18/210 Li - Solo	TE-TS 36/210 Li - Solo	TE-SM 254 Dual	TE-SM 2534 Dual	TC-SM 2534/1 Dual	TC-SM 254	TC-SM 2531/2 U	TE-SM 2131 Dual	TE-SM 216 Dual	TC-SM 2131/2 Dual	TC-SM 216	TC-MS 2513 L	TC-MS 2112	TC-MS 216	TC-MS 3017 T	TE-CC 250 UF	TE-TS 250 UF	TC-TS 2225 U	TC-TS 254 U	TC-TS 2025/2 U	TC-TS 2025/3 eco	TC-TS 254 eco	TE-TS 315 UD	TE-TS 315 U	TC-TS 315	TE-TS 254 T	TC-TS 210
ø 200 mm	HM Ø 200 x 16 x 2,4 mm   t20	49587151	-	-	-	-	-	-	-	-	-	-	-	-	-	-	-	-	-	-	-	-	-	-	-	-	-	-	-	•
ø 210 mm	HM-Dü Ø 210 x 30 x 1,8 mm   t40	49587852	•	•	•	-	-	-	-	•	-	-	-	•	-	-	-	-	-	-	-	-	-	-	-	-	-	-	-	-
	HM Ø 210 x 30 x 2,4 mm   t48	49587861	•	•	•	-	-	-	-	•	-	•	-	-	-	-	-	-	-	-	-	-	-	-	-	-	-	-	-	-
	HM-Dü Ø 210 x 30 x 1,8 mm   t64	49587862	•	•	•	-	-	-	-	•	-	-	-	•	-	-	-	-	-	-	-	-	-	-	-	-	-	-	-	-
	HM Ø 210 x 30 x 2,5 mm   t24/t42/t60	49587805	•	•	•	-	-	-	-	•	-	•	-	-	•	-	-	-	-	-	-	-	-	-	-	-	-	-	-	•
ø 216 mm	HM Ø 216 x 30 x 2,4 mm   t60	49588261	-	-	-	-	-	-	-	•	•	-	-	•	-	-	-	-	-	-	-	-	-	-	-	-	-	-	-	-
	HM Ø 216 x 30 x 2,4 mm   t48	49588251	-	-	-	-	-	-	-	•	•	-	-	•	-	-	-	-	-	-	-	-	-	-	-	-	-	-	-	-
	HM Ø 216 x 30 x 2,4 mm   t24/t42/t60	49587806	-	-	-	-	-	-	-	•	•	-	-	•	-	-	-	-	-	-	-	-	-	-	-	-	-	-	-	-
ø 250 mm	HM-Dü Ø 250 x 30 x 1,8 mm   t42	49589352	-	-	-	•	•	-	-	-	-	-	•	-	-	-	-	-	-	-	-	-	-	-	-	-	-	-	-	-
	HM Ø 250 x 30 x 3,2 mm   t24	49589341	-	-	-	•	•	-	-	-	-	-	•	-	-	-	-	-	•	•	-	-	•	•	-	-	-	-	-	-
	HM Ø 250 x 30 x 3,2 mm   t48	49589351	-	-	-	•	•	-	-	-	-	-	•	-	-	-	-	-	•	•	-	-	•	•	-	-	-	-	-	-
	HM Ø 250 x 30 x 3,2 mm   t60	49589552	-	-	-	•	•	-	-	-	-	-	•	-	-	-	-	-	•	•	-	-	•	•	-	-	-	-	-	-
	HM Ø 250 x 30 x 3,2 mm   t24/t60	49589305	-	-	-	•	•	-	-	-	-	-	•	-	-	-	-	-	•	•	-	-	•	•	-	-	-	-	-	-
	HM Ø 250 x 30 x 3,2 mm   t24/t42/t60	49589306	-	-	-	•	•	-	-	-	-	-	•	-	-	-	-	-	•	•	-	-	•	•	-	-	-	-	-	-
ø 254 mm	HM-Dü Ø 254 x 30 x 1,8 mm   t42	49589361	-	-	-	•	-	•	•	-	-	-	-	-	-	-	-	-	-	-	-	-	-	-	-	-	-	-	-	-
	HM Ø 254 x 30 x 3,2 mm   t48	49589551	-	-	-	•	-	•	•	-	-	-	-	-	-	-	-	-	-	•	•	-	-	•	-	-	-	•	-	-
	HM Ø 254 x 30 x 3,2 mm   t60	49589561	-	-	-	•	-	•	•	-	-	-	-	-	-	-	-	-	-	•	•	-	-	•	-	-	-	•	-	-
	HM Ø 254 x 30 x 3,2 mm   t24/t42/t60	49589307	-	-	-	•	-	•	•	-	-	-	-	-	-	-	-	-	-	•	•	-	-	•	-	-	-	•	-	-
ø 305 mm	HM Ø 305 x 30 x 3,0 mm   t40	49592957	-	-	-	-	-	-	-	-	-	-	-	-	-	-	-	•	-	-	-	-	-	-	-	-	-	-	-	
ø 315 mm	HM Ø 315 x 30 x 3,2 mm   t48	49593151	-	-	-	-	-	-	-	-	-	-	-	-	-	-	-	-	-	-	-	-	-	-	•	•	•	-	-	-

• Use possible    – Use not possible



**STATIONARY PLANERS ACCESSORIES**

	Type	Article number	EAN	Can be used for	Length	Height	Thickness	Quantity
	Spare Blades	49568602	4 009315 686028	TH-SP 204, TC-SP 204	210 mm	17.2 mm	1.5 mm	2 pcs

**SCROLL SAWS ACCESSORIES**

	Type	Article number	EAN	Quantity	Length	Size	Can be used for
	Scroll Saw Blade Set	49316350	4 009313 163507	5 pcs	127 mm	1x size 1 (fine), 2x size 3 (medium), 1x size 4 (medium-rough), 1x size 11 (rough)	Wood
	Scroll Saw Blade Set	49316352	4 009313 163521	10 pcs	127 mm	0 (extra-fine)	Wood

**BAND SAWS ACCESSORIES**

	Type	Article number	EAN	Length	Width	Thickness	Number of teeth	Can be used for
	Saw Band	49081505	4 009310 815058	1400 mm	8.0 mm	0.65 mm	6/25.4 mm	Wood
	Saw Band	49081506	4 009310 815065	1712 mm	6.0 mm	0.65 mm	6/25.4 mm	Wood
	Saw Band	49081509	4 009310 815096	2320 mm	13 mm	0.65 mm	4/25.4 mm	Wood
	Saw Band Set, 3-piece	45.061.60	4 006825 663112	1141 mm	12.7 mm	0.65 mm	10/14 per inch	Wood / metal / plastic

**WOODWORKING LATHES ACCESSORIES**

	Type	Article number	EAN	Items supplied	Comprising
	Turning Tools Set	49455250	4 009314 552508	5-piece	Flat chisel, mortise chisel, gouge, round chisel, pointed chisel (1 of each)

**WOODWORKING LATHES ACCESSORIES**

	Type	Article number	EAN	Mount	Gripping diameter outer jaws	Gripping diameter inner jaws	Product weight
	Four-Jaw Chuck	49455295	4 009314 552959	Inner thread M18	45 - 134 mm	18 - 52 mm	2.5 kg

**LASER TECHNOLOGY ACCESSORIES**

	Type	Article number	EAN	Hose length / hose diameter	Ø adapter	Extractor adapter up to 36 mm	Blind stoppers
	Vacuum Adapter Set	43.106.30	4 006825 587715	1200 mm / 36 mm	100 mm	•	•

**CORDLESS WET AND DRY VACUUM CLEANERS / WET AND DRY VACUUM CLEANERS ACCESSORIES**

	Type	Article number	EAN	For tank volume	Quantity	Suitable for
	Foam Filters 10 l	23.511.35	4 006825 641424	10 l	5 pcs	TE-VC 18/10 Li
	Dirt Bags 10 l	23.512.60	4 006825 641394	10 l	5 pcs	TE-VC 18/10 Li
	Fabric Filter	23.511.40	4 006825 231151	–	1 pc	see list on page 152
	Foam Filters, big	23.511.34	4 006825 659368	–	5 pcs	see list on page 152
	Foam Filters	23.511.32	4 006825 644098	–	5 pcs	see list on page 152
	Non-woven Bags 40 l	23.511.95	4 006825 625691	30 - 50 l	5 pcs	see list on page 152
	Non-woven Bags 25 l	23.511.90	4 006825 625684	15 - 25 l	5 pcs	see list on page 152
	Non-woven Bags 15 l	23.511.85	4 006825 625554	12 - 15 l	5 pcs	see list on page 152
	Dirt Bags 40 l	23.511.80	4 006825 607468	40 - 50 l	5 pcs	see list on page 152
	Dirt Bags 30 l	23.511.70	4 006825 528763	30 l	5 pcs	see list on page 152
	Dirt Bags 25 l	23.511.50	4 006825 231281	25 l	5 pcs	see list on page 152
	Dirt Bags 20 l	23.511.52	4 006825 236040	15 - 20 l	5 pcs	see list on page 152
	Dirt Bags 12 l	23.511.59	4 006825 606065	12 - 15 l	5 pcs	see list on page 152

**CORDLESS WET AND DRY VACUUM CLEANERS / WET AND DRY VACUUM CLEANERS ACCESSORIES**

	Fine Ash Filter	Ash Filter
Capacity	18 l	12 l
Items supplied	1 pc	1 pc
Suction hose length / diameter	100 cm / 36 mm	100 cm / 36 mm
Suitable for	see list on page 152	see list on page 152
Article number	23.516.12	23.516.06















4 006825 548938



4 006825 578041

**CORDLESS WET AND DRY VACUUM CLEANERS / WET AND DRY VACUUM CLEANERS ACCESSORIES**

Type	Article number	EAN	Items supplied	Suitable for
 Dual Dust Filter System	23.512.50	4 006825 630138	1 HEPA filter (class H13 (> 0,3 µm)), 1 dual filter bag	see list on page 152
 Pleated Filter for dust class L	23.511.26	4 006825 657944	1 pc	see list on page 152
 Pleated Filter	23.511.10	4 006825 231090	1 pc	see list on page 152
 Pleated Filter with Lid	23.511.13	4 006825 566512	1 pc	see list on page 152
 Flexible Crevice Nozzle, long	23.512.04	4 006825 653953	1 pc	see list on page 152
 Small Universal Nozzle	23.512.10	4 006825 630053	1 pc	see list on page 152
 Universal Floor Nozzle	23.512.15	4 006825 630060	1 pc	see list on page 152
 Drilling Nozzle	23.512.33	4 006825 653960	1 pc	see list on page 152
 Hard Upholstery Brush	23.512.20	4 006825 630077	1 pc	see list on page 152
 Soft Upholstery Brush	23.512.25	4 006825 630084	1 pc	see list on page 152
 Round Carpet Brush	23.512.30	4 006825 630091	1 pc	see list on page 152
 Set of Nozzles	23.512.35	4 006825 630107	2 nozzles, 1 brush	see list on page 152

**CORDLESS WET AND DRY VACUUM CLEANERS / WET AND DRY VACUUM CLEANERS ACCESSORIES**



	Car Cleaning Set	Premium Suction Hose	Suction Hose
Items supplied	6-piece set	1 heavy-duty suction hose, 3 adapters	1 hose, 3 adapters
Suction hose length	300 cm	300 cm	300 cm
Suction hose diameter	36 mm	36 mm	36 mm
Suitable for	see list on page 152	see list on page 152	see list on page 152
Article number	23.512.45	23.620.05	23.620.00



**CORDLESS STICK VAC  
CLEANERS ACCESSORIES**



	Replacement Brush <span style="float: right;">NEW</span>	Replacement Filter <span style="float: right;">NEW</span>	Accessories Set <span style="float: right;">NEW</span>
Items supplied	1 brush	1 filter	1 hose, 1 crevice nozzle, 1 upholstery nozzle
Suitable for	TE-SV 18 Li	TE-SV 18 Li	TE-SV 18 Li
Feature	Easily changeable	Washable	Hose diameter 36 mm for several nozzles and attachments
Article number	23.512.65	23.512.66	23.512.67



Replacement Brush 23.512.65



Replacement Filter 23.512.66













Accessories Set 23.512.67





Accessories Set 23.512.67





HIGH PRESSURE CLEANERS ACCESSORIES						
	Type	Article number	EAN	Max. operation pressure	Length	Quantity
	Patio Cleaner	41.440.15	4 006825 652000	170 bar	–	1
	Washing Brush	41.440.16	4 006825 652246	170 bar	–	1
	Rotating Brush	41.440.17	4 006825 652253	170 bar	–	1
	Horizontal Brush	41.440.18	4 006825 652260	170 bar	–	1
	PVC High Pressure Hose	41.440.19	4 006825 652277	200 bar	6 m	1
	Angled Nozzle	41.440.20	4 006825 652284	180 bar	–	1
	Foam producer	41.440.21	4 006825 652291	170 bar	–	1
	Turbo Nozzle	41.440.22	4 006825 652307	170 bar	–	1
	Pipe Cleaning Hose	41.440.23	4 006825 652314	200 bar	15 m	1
	Metal Extension with Angled Nozzle	41.440.24	4 006825 652321	180 bar	–	1



**CORDLESS TACKERS AND COMPRESSED AIR STAPLERS/NAILERS ACCESSORIES**







	Type	Article number	EAN	Type	Length	Width	Quantity	Suitable for	Packaging
	Staples	41.378.61	4 006825 505788	E, chisel points	40 mm	5.7 mm	3000 pcs	TC-PN 50	Colour box
	Staples	41.378.60	4 006825 504446	E, chisel points	25 mm	5.7 mm	3000 pcs	TC-PN 50	Colour box
	Staples	41.378.55	4 006825 504439	E, chisel points	16 mm	5.7 mm	3000 pcs	TE-CN 18 Li   TC-PN 50	Colour box
	Staples	41.378.50	4 006825 504422	E, chisel points	13 mm	5.7 mm	3000 pcs	TC-PN 50	Colour box
	Nails	41.378.73	4 006825 505795	J	50 mm	1.0 mm	3000 pcs	TC-PN 50	Colour box
	Nails	41.378.72	4 006825 504866	J	40 mm	1.0 mm	3000 pcs	TC-PN 50	Colour box
	Nails	41.378.71	4 006825 504460	J	25 mm	1.0 mm	3000 pcs	TE-CN 18 Li   TC-PN 50	Colour box

**COMPRESSED AIR ROTATING SANDERS ACCESSORIES**













	Type	Article number	EAN	Items supplied	Ø	Grit size	With holes	Suitable for
	Abrasive Paper Set	49492095	4 009314 920956	5 pcs	150 mm	2x 40 grit, 2x 80 grit, 1x 120 grit	•	TC-PE 150

**COMPRESSED AIR HAMMERS ACCESSORIES**

	Type	Article number	EAN	Items supplied	Suitable for	Packaging
	Needle Scaler Attachment	41.331.20	4 006825 645873	1 pc	TC-PC 45 / TC-PC 45 Set	Colour box
	Chisels Set	41.327.69	4 006825 653946	4 pcs	TC-PC 45 / TC-PC 45 Set	Colour box
	Tensioning Spring	41.327.68	4 006825 650013	1 pc	TC-PC 45 / TC-PC 45 Set	Blister

COMPRESSED AIR ACCESSORIES					
	Type	Article number	EAN	Properties	Packaging
	Fabric Hose	41.382.10	4 006825 574166	Length 15 m, Ø internal: 9 mm	Shrink film
	Fabric Hose	41.382.00	4 006825 410099	Length 15 m, Ø internal: 6 mm	Shrink film
	Fabric Hose	41.381.00	4 006825 410082	Length 10 m, Ø internal: 6 mm	Shrink film
	Spiral Hose	41.394.20	4 006825 411744	Length 8 m, Ø internal: 6 mm	Shrink film
	Spiral Hose	41.394.10	4 006825 411737	Length 4 m, Ø internal: 6 mm	Shrink film
	Inflation Adapters Kit	41.396.95	4 006825 511475	8-piece	Colour box
	Mini Oiler	41.350.02	4 006825 581614	R 1/4" internal thread, R 1/4" external thread	Blister
	Filter + Pressure Reducer	41.342.00	4 006825 410051	Complete with nipple and quick-lock coupling R 1/4"	Colour box
	Filter + Pressure Reducer	41.341.00	4 006825 410044	Complete with nipple and quick-lock coupling R 3/8"	Colour box
	Combination Conditioning Unit	41.350.01	4 006825 410181	Complete with oiler, nipple and quick-lock coupling R 1/4"	Colour box
	Combination Conditioning Unit	41.350.00	4 006825 410075	Complete with oiler, nipple and quick-lock coupling R 3/8"	Colour box
	Special Compressed Air Oil	41.383.10	4 006825 411270	500 ml	Plastic bottle
	Abrasive Sand	41.383.11	4 006825 663877	1 kg, grain size 0.2-0.35 mm	Plastic bottle

**COMPRESSED AIR ACCESSORIES**



	Type	Article number	EAN	Properties	Packaging
	Michelin Nipple	41.393.30	4 006825 588712	Ø 6 mm	Blister
	Quick-lock Coupling	41.392.06	4 006825 410334	R 1/4" IT	Blister
	Quick-lock Coupling	41.392.07	4 006825 560824	R 1/4" ET	Blister
	Quick-lock Coupling	41.392.05	4 006825 410327	R 3/8" IT	Blister
	Quick-lock Coupling	41.392.08	4 006825 560831	R 3/8" ET	Blister
	Quick-lock Coupling	41.392.10	4 006825 599046	R 1/2" internal thread	Blister
	Quick-lock Coupling	41.392.09	4 006825 596939	R 1/2" external thread	Blister
	Quick-lock Coupling	41.393.01	4 006825 581638	Ø 6 mm	Blister
	Quick-lock Coupling	41.393.02	4 006825 581645	Ø 9 mm	Blister
	Distributor	41.396.80	4 006825 411713	2 quick-lock couplings 3/8" IT	Blister
	Threaded Grommet	41.396.65	4 006825 581676	Ø 6 mm, R 1/4" et	Blister
	Threaded Grommet	41.396.66	4 006825 581669	Ø 6 mm, R 3/8" et	Blister
	Threaded Nipple	41.396.55	4 006825 562347	R 1/4" external thread	Blister
	Threaded Nipple	41.396.50	4 006825 411683	R 3/8" external thread	Blister
	Threaded Nipple	41.396.40	4 006825 411676	R 1/4" internal thread	Blister
	Threaded Nipple	41.396.45	4 006825 581683	R 3/8" internal thread	Blister
	Grommet	41.396.60	4 006825 411690	Ø 6 mm	Blister
	Grommet	41.396.61	4 006825 581621	Ø 9 mm	Blister
	Double Nipple	41.396.20	4 006825 411652	R 1/4" external thread	Blister
	Double Nipple	41.396.10	4 006825 411645	R 3/8" external thread	Blister
	Reduction	41.396.00	4 006825 411621	R 3/8" et auf R 1/4" it	Blister
	Reduction	41.396.05	4 006825 562330	R 1/2" et auf R 3/8" it	Blister
	Reduction	41.396.30	4 006825 411669	R 3/8" et auf R 1/4" et	Blister
	Hose Connection Tube	41.393.10	4 006825 411720	Ø 6 mm	Blister
	Hose Connection Tube	41.393.20	4 006825 581652	Ø 9 mm	Blister
	Hose Connector Kit	41.395.00	4 006825 410136	Ø 6 mm	Blister
	Clip Kit	41.396.70	4 006825 411706	5 pcs, 8 - 12 mm	Blister

**ASSIGNMENT OF AIR TOOLS AND ACCESSORIES TO COMPRESSORS**

		TE-AC 36/6/8 Li OF Set	TE-AC 36/8 Li OF Set	PRESSITO	PRESSITO 18/21	TE-AC 50 Silent	TE-AC 24 Silent	TE-AC 6 Silent	TE-AC 430/90/10	TC-AC 420/50/10 V	TE-AC 270/50/10	TE-AC 270/24/10	TE-AC 230/24/8	TC-AC 190/50/8	TC-AC 190/24/8	TC-AC 240/50/10 OF	TC-AC 200/24/8 OF	TC-AC 190/6/8 OF Set	TC-AC 190/6/8 OF	TC-AC 190 OF Set
		40.204.50	40.204.40	40.204.60	40.204.67	40.206.20	40.206.10	40.206.00	40.108.00	40.104.95	40.104.40	40.104.50	40.104.60	40.073.32	40.073.25	40.103.93	40.205.90	40.206.50	40.204.95	40.206.60
TC-PN 50 – Stapler/Nailer	41.377.90	•	-	-	-	•	•	•	•	•	•	•	•	•	•	•	•	•	•	-
TC-PW 610 Compact – Impact Wrench	41.389.65	-	-	-	-	-	-	-	•	•	-	-	-	-	-	-	-	-	-	-
TC-PW 610 – Impact Wrench	41.389.60	-	-	-	-	-	-	-	•	•	-	-	-	-	-	-	-	-	-	-
TC-PW 340 – Impact Wrench	41.389.50	-	-	-	-	•	-	-	•	•	•	•	•	-	-	•	-	-	-	-
TC-PP 220 – Straight Grinder	41.385.40	-	-	-	-	-	-	-	•	•	-	-	-	-	-	-	-	-	-	-
TC-PC 45 – Hammer	41.390.40	-	-	-	-	-	-	-	•	•	-	-	-	-	-	-	-	-	-	-
TC-PC 45 Set – Hammer	41.390.45	-	-	-	-	-	-	-	•	•	-	-	-	-	-	-	-	-	-	-
TC-PR 68 – Ratchet Screwdriver	41.391.80	-	-	-	-	•	-	-	•	•	•	•	•	-	-	•	-	-	-	-
TC-PE 150 – Rotating Sander	41.333.30	-	-	-	-	-	-	-	•	•	-	-	-	-	-	-	-	-	-	-
Blow-out Pistol with 4 Nozzles	41.327.62	•	•	-	-	•	•	•	•	•	•	•	•	•	•	•	•	•	•	•
Blow-out Pistol with 500 mm Nozzle	41.327.63	•	•	-	-	•	•	•	•	•	•	•	•	•	•	•	•	•	•	•
Blow-out Pistol, long	41.331.02	•	•	-	-	•	•	•	•	•	•	•	•	•	•	•	•	•	•	•
Blow-out Pistol, short	41.331.00	•	•	-	-	•	•	•	•	•	•	•	•	•	•	•	•	•	•	•
Blow-out Pistol Set	41.327.59	•	•	-	-	•	•	•	•	•	•	•	•	•	•	•	•	•	•	•
Tyre Pressure Gauge, digital	41.331.15	•	•	-	-	•	•	•	•	•	•	•	•	•	•	•	•	•	•	•
Pro Tyre Pressure Gauge	41.331.10	•	•	-	-	•	•	•	•	•	•	•	•	•	•	•	•	•	•	•
Tyre pressure gauge	41.370.00	•	•	-	-	•	•	•	•	•	•	•	•	•	•	•	•	•	•	•
Pro Paint Spray Gun	41.330.30	-	-	-	-	•	-	-	•	•	•	•	•	-	-	•	-	-	-	-
Paint Spray Gun, cup	41.330.00	-	-	-	-	•	-	-	•	•	•	•	•	-	-	•	-	-	-	-
Paint Spray Gun, suction-feed can	41.329.00	-	-	-	-	•	-	-	•	•	•	•	•	-	-	•	-	-	-	-
Spray Gun	41.332.00	-	-	-	-	•	-	-	•	•	•	•	•	-	-	•	-	-	-	-
Jet Gun	41.333.00	-	-	-	-	-	-	-	•	•	-	-	-	-	-	-	-	-	-	-
Suction Spray Gun	41.334.20	-	-	-	-	-	-	-	•	•	-	-	-	-	-	-	-	-	-	-
Underseal Gun	41.335.01	-	-	-	-	•	-	-	•	•	•	•	•	-	-	•	-	-	-	-
Air Tool Set, 13-piece	41.327.76	-	-	-	-	-	-	-	•	•	-	-	-	-	-	-	-	-	-	-
Air Tool Set, 10-piece	40.205.77	-	-	-	-	•	-	-	•	•	•	•	•	-	-	•	-	-	-	-
Pro Compressed Air Set, 5-piece	41.327.20	-	-	-	-	•	-	-	•	•	•	•	•	-	-	•	-	-	-	-
Compressed Air Set, 3-piece	41.327.41	•	•	-	-	•	•	•	•	•	•	•	•	•	•	•	•	•	•	•

• Use possible    - Use not possible

**TILE CUTTING MACHINES ACCESSORIES**

	Type	Article number	EAN	Ø	Ø hole	Rim shape
	Diamond Cutting Wheel	49795850	4 009317 958505	180 mm	25.4 mm	Continuous rim
	Diamond Cutting Wheel	49795855	4 009317 958550	200 mm	25.4 mm	Continuous rim
	Turbo Diamond Cutting Wheel	49797650	4 009317 976509	180 mm	25.4 mm	Turbo
	Turbo Diamond Cutting Wheel	49797750	4 009317 977506	200 mm	25.4 mm	Turbo
	Turbo Diamond Cutting Wheel	49797851	4 009317 978510	250 mm	25.4 mm	Turbo
	Turbo Diamond Cutting Wheel	49797950	4 009317 979500	300 mm	25.4 mm	Turbo

**BENCH GRINDERS ACCESSORIES**

	Type	Article number	EAN	Ø	Ø hole	Wheel thickness	Grit size	Reducing rings
	Polishing Wheel	49507045	4 009315 070452	75 mm	10 mm	20 mm	400	–
	Grinding Wheel	49507125	4 009315 071251	75 mm	10 mm	20 mm	120	–
	Grinding Wheel	49507465	4 009315 074658	150 mm	32 mm	16 mm	60	12.7 mm
	Grinding Wheel	49507435	4 009315 074351	150 mm	32 mm	16 mm	36	12.7 mm
	Grinding Wheel	49507565	4 009315 075655	150 mm	32 mm	20 mm	60	12.7 mm
	Grinding Wheel	49507535	4 009315 075358	150 mm	32 mm	20 mm	36	12.7 mm
	Grinding Wheel	49507885	4 009315 078854	200 mm	20 mm	40 mm	200	–
	Grinding Wheel	49507765	4 009315 077659	200 mm	32 mm	25 mm	60	16 mm
	Grinding Wheel	49507735	4 009315 077352	200 mm	32 mm	25 mm	36	16 mm



**GRINDING AND ENGRAVING TOOLS ACCESSORIES**

	Type	Article number	EAN	Items supplied	Can be used for	Packaging
	Accessories Set	49510951	4 009315 109510	38-piece	Grinding/engraving tools and bench grinders	Storage case

### WET GRINDERS ACCESSORIES

	Type	Article number	EAN	Properties
	Leather Honing Wheel	49507886	4 009315 078861	Ø 180 mm, Ø hole 12.7 mm, wheel thickness 30 mm

### BELT-DISC SANDERS ACCESSORIES

	Type	Article number	EAN	Dimensions	Quantity	Grit size
	Grinding Belt Set	49910805	4 009319 108052	686 x 50 mm	5 pcs	2x 60 grit, 2x 80 grit, 1x 120 grit
	Grinding Belt Set	49914605	4 009319 146054	914 x 100 mm	3 pcs	60 grit, 80 grit, 120 grit – 1 of each
	Abrasive Paper Set	49492074	4 009314 920741	Ø 150 mm	3 pcs	80 grit

### BENCH DRILLS ACCESSORIES

	Type	Article number	EAN	Jaw width	Clamping range	Slot spacing
	Bench Vice	49777015	4 009317 770152	80 mm	max. 68 mm	85 mm from mid-point to mid-point

### METAL CUTTING SAWS ACCESSORIES

	Type	Article number	EAN	Ø	Ø hole	Thickness
	Cutting Wheel	49791975	4 009317 919759	355 mm	25.4 mm	3.2 mm

### POWER TOOLS ACCESSORIES

	Type	Article number	EAN	Suction hose length	Tank volume
	Petrol and Oil Suction Pump	34.070.00	4 006825 547276	1.3 m	1.6 l

# SALES SUPPORT

## POS | SHOP IN SHOP SYSTEM



- **Flagship Shop in Shop Concept**  
(according to catalog 'Modular Display Concept')

## PRINT PRODUCTS



- **Folders**



- **Brochures**



## POS | PERMANENT SECONDARY DISPLAYS



- **Modular Display Power X-Change Garden**  
**120 x 80 cm**  
(according to catalog 'Modular Display Concept')



- **Modular Display Power X-Change Power Tools**  
**120 x 80 cm**  
(according to catalog 'Modular Display Concept')



- **Wall display Power X-Change Tools + Power Tools**  
(according to catalog 'Prime Wall Display Concept')



**CRAZY DIY**  
**THE TINKERER**

**FRANK**  
**THE BOSS**



WHO IS THE E-TEAM?  
WHAT DOES THE E-TEAM DO?  
FIND ALL THE ANSWERS AT  
[WWW.EINHELL.DE](http://WWW.EINHELL.DE)

**THE**



**TEAM**



Official Home & Garden Expert

**OLIVER KAHN**  
**THE CLIENT**

**SKYE**  
**THE COOL**

**MIKE**  
**THE MUSCLE**



Allian Arena

**THEIR MISSION:**  
**TO ENABLE.**



# POWER TOOLS 2022

Is there anything you´d like to ask us about our products?  
Would you like to order a part?  
Your product isn´t working as it should?  
We´re at your service!  
We´ll get you some help – fast and without any fuss.



**Einhell-Service**  
Eschenstr. 6  
94405 Landau/Isar  
Germany



+ 49 (0) 9951 959 2000



+ 49 (0) 9951 959 1700



[einhell-service.de](http://einhell-service.de)



[Service-DE@einhell.com](mailto:Service-DE@einhell.com)

**Einhell Germany AG**  
Wiesenweg 22  
94405 Landau / Isar – Germany  
[info@einhell.de](mailto:info@einhell.de) – [www.einhell.de](http://www.einhell.de)